

LOCKING CIRCUIT BOARD SUPPORTS

Buy One or Buy Bulk & SAVE

BHDF Metric Double Blind Hole Mount Circuit Board Support

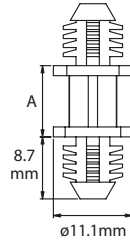
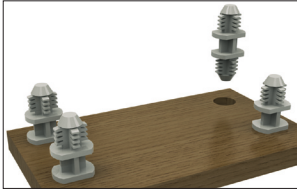

Top Hole:
Press-fit: 7.92mm
Panel Thickness:
6.4mm Min.

Bottom Hole:
Press-fit: 7.92mm
Panel Thickness:
6.4mm Min.

- Fir-tree mount is flexible and will lock into round, threaded, punched or drilled blind holes
- Material: UL94 V-2 Nylon 6/6
- Color: Natural

Item No.	"A" Standoff Height mm	Bulk Pack Qty.
BHDF-3M-01	3	1000
BHDF-4M-01	4	1000
BHDF-6M-01	6	1000
BHDF-8M-01	8	1000
BHDF-10M-01	10	1000
BHDF-12M-01	12	1000
BHDF-14M-01	14	1000
BHDF-16M-01	16	1000
BHDF-18M-01	18	1000
BHDF-20M-01	20	1000

DLCBSHD Metric Dual Locking Circuit Board Support Heavy Duty

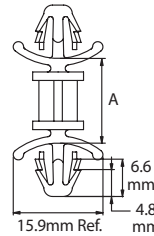
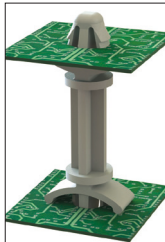

Top Hole:
Snap-lock: 6.3mm
Panel Thickness:
0.8 - 2.2mm

Bottom Hole:
Snap-lock: 6.3mm
Panel Thickness:
0.8 - 2.2mm

- Larger design provides a strong, sturdy mounting method for heavily loaded PCBs
- Easily installed by hand
- Material: Nylon 6/6
- Color: Natural

Item No.	"A" Standoff Height mm	Bulk Pack Qty.
Material: UL94 V-2	Material: UL94 V-0	
DLCBSHD-10M-01	DLCBSHD-10M-19	10 1000
DLCBSHD-20M-01	DLCBSHD-20M-19	20 1000
DLCBSHD-25M-01	DLCBSHD-25M-19	25 1000
DLCBSHD-30M-01	DLCBSHD-30M-19	30 1000
DLCBSHD-35M-01	DLCBSHD-35M-19	35 1000

DLCBS2 Dual Locking Circuit Board Support

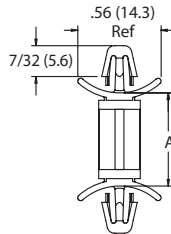

Top Hole:
Snap-lock: .187 (4.75)
Panel Thickness:
.031 - .078 (0.79 - 1.98)

Bottom Hole:
Snap-lock: .187 (4.75)
Panel Thickness:
.031 - .078 (0.79 - 1.98)

- Both ends lock by hand, no tools required
- Wings provide a tight fit to the boards and allow for various panel thicknesses
- Nylon 6/6
- Color: Natural

Item No.	"A" Standoff Height	Bulk Pack Qty.
Material: UL94 V-2	Material: UL94 V-0	
DLCBS2-3-01	DLCBS2-3-19	3/16 (4.8) 1000
DLCBS2-4-01	DLCBS2-4-19	1/4 (6.4) 1000
DLCBS2-6-01	DLCBS2-6-19	3/8 (9.5) 1000
DLCBS2-8-01	DLCBS2-8-19	1/2 (12.7) 1000
DLCBS2-9-01	DLCBS2-9-19	9/16 (14.3) 1000
DLCBS2-10-01	DLCBS2-10-19	5/8 (15.9) 1000
DLCBS2-12-01	DLCBS2-12-19	3/4 (19.1) 1000
DLCBS2-14-01	DLCBS2-14-19	7/8 (22.2) 1000

DLCBSRA3 Double Locking Support

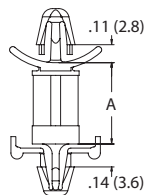

Top Hole:
Snap-lock: .117 (4.8)
Panel Thickness:
.031 - .078 (0.8 - 2.0)

Bottom Hole:
Snap-lock: .187 (4.8)
Panel Thickness:
.031 - .078 (0.8 - 2.0)

- Specifications:
- Material: Nylon 6/6
 - Color: Natural
 - Flame Class: UL94 V-2

Item No.	In	A mm	Bulk Pack Qty.
DLCBSRA3-6-01	0.188	4.8	1000
DLCBSRA3-8-01	0.500	12.7	1000
DLCBSRA3-10-01	0.625	15.9	1000
DLCBSRA3-12-01	0.750	19.1	1000
DLCBSRA3-14-01	0.875	22.2	1000

SP2 Support Post

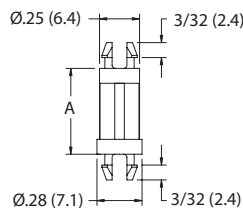
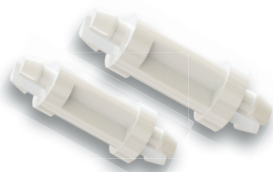

Snap-Lock:
.187 (4.8)
Panel Thickness:
.062 (1.6)

Snap-Lock:
.187 (4.8)
Panel Thickness:
.062 (1.6)

- Specifications:
- Material: Nylon 6/6
 - Color: Natural
 - Flame Class: UL94 V-2

Item No.	In	A mm	Bulk Pack Qty.
SP2-3-01	0.188	4.8	1000
SP2-4-01	0.250	6.4	1000
SP2-6-01	0.375	9.5	1000
SP2-8-01	0.500	12.7	1000
SP2-10-01	0.625	15.9	1000
SP2-12-01	0.750	19.1	1000
SP2-14-01	0.875	22.2	1000
SP2-16-01	1.000	25.4	1000

LOCKING CIRCUIT BOARD SUPPORTS



CBSP PCB Spring Spacer

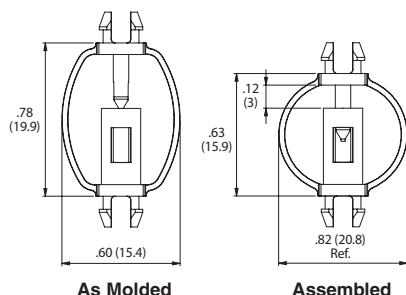

Top Hole:
 Snap-lock: .189 (4.8)
 Panel Thickness: .062 (1.57)

Bottom Hole:
 Snap-lock: .189 (4.8)
 Panel Thickness: .062 (1.57)



- When pin is inserted into spacer, part flexes and acts as a plastic spring
- One piece design reduces the need for hardware
- Provides continuous support to PCB
- Keeps light sensors on the PCB in constant contact with touch control cover
- Material: UL94 HB Acetal
- Color: Natural

Item No.	Bulk Pack Qty
CBSP-1	1000

CBSPM Rubber Pull Mount Circuit Board Support

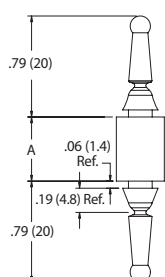
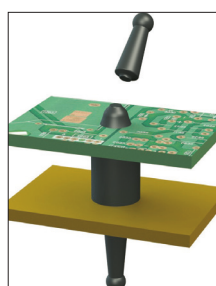

Top Hole:
 Snap-fit: .187 (4.75)
 Panel Thickness: .094 (2.4) Max

Bottom Hole:
 Snap-fit: .187 (4.75)
 Panel Thickness: .094 (2.4) Max



- Rubber spacer provides shock and vibration protection
- Pull mount ends are easily fed into panel holes and pulled into a locked position
- Once installed, the ends are easily cut off leaving low profile mounting ends
- Material: EPDM, 45 Shore A
- Color: Black

Item No.	"A" Standoff Height	Bulk Pack Qty.
CBSPM-4	.250 (6.35)	500
CBSPM-6	.375 (9.53)	500
CBSPM-8	.500 (12.7)	500
CBSPM-10	.625 (15.88)	500
CBSPM-12	.750 (19.05)	500

LCBS Series Locking Support

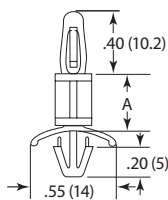

To Lock in Hole:
 .156 (4)
 Panel Thickness: .047-.067 (1.2-1.7)

To Lock in Hole:
 .187 (4.8)
 Panel Thickness: .031-.078 (0.8-2.0)

Specifications:

- Material: Nylon 6/6
- Color: Natural
- Flame Class: UL94 V-2

Item No.	In	A mm	Bulk Pack Qty.
CBLS005A	0.138	3.5	1000
LCBS-3-01	0.187	4.8	1000
LCBS-6M-01	0.236	6.0	1000
LCBS-4-01	0.250	6.4	1000
LCBS-5-01	0.312	7.9	1000
LCBS-6-01	0.375	9.5	1000
LCBS-7-01	0.437	11.1	1000
LCBS-8-01	0.500	12.7	1000
LCBS-10-01	0.625	15.9	1000

Item No.	In	A mm	Bulk Pack Qty.
LCBS-12-01	0.750	19.1	1000
LCBS-14-01	0.875	22.2	1000
CBLS060A	0.945	24.0	1000
LCBS-16-01	1.000	25.4	1000
LCBS-18-01	1.125	28.6	1000
CBLS075A	1.224	31.1	1000
LCBS-20-01	1.250	31.7	1000
LCBS-22-01	1.375	34.9	1000

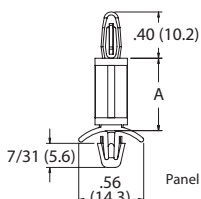

Top Hole:
 Snap-lock: .156 (4.0)
 Panel Thickness: .062 (1.57)

Bottom Hole:
 Snap-lock: .187 (4.8)
 Panel Thickness: .031-.078 (0.8-2.0)

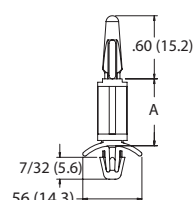

Top Hole:
 Snap-fit: .156 (4.0)
 Panel Thickness: .062 (1.57)

Bottom Hole:
 Snap-lock: .187 (4.8)
 Panel Thickness: .031-.078 (0.8-2.0)



Item No.	UL94 V-2	UL94 V-0	A In	A mm	Bulk Pack Qty.
LCBS-2-3-01	LCBS-2-3-19		0.188	4.8	1000
LCBS-2-4-01	LCBS-2-4-19		0.250	6.4	1000
LCBS-2-5-01	LCBS-2-5-19		0.313	7.9	1000
LCBS-2-6-01	LCBS-2-6-19		0.375	9.5	1000
LCBS-2-7-01	LCBS-2-7-19		0.438	11.1	1000
LCBS-2-8-01	LCBS-2-8-19		0.500	12.7	1000
LCBS2-10-01	LCBS2-10-19		0.625	15.9	1000

Item No.	UL94 V-2	UL94 V-0	A In	A mm	Bulk Pack Qty.
LCBS2-12-01	LCBS2-12-19		0.750	19.1	1000
LCBS2-14-01	LCBS2-14-19		0.875	22.2	1000
LCBS2-16-01	LCBS2-16-19		1.000	25.4	1000
LCBS2-18-01	LCBS2-18-19		1.125	28.6	1000
LCBS2-20-01	LCBS2-20-19		1.250	31.8	1000
LCBS2-22-01	LCBS2-22-19		1.375	34.9	1000



Item No.	A In	A mm	Bulk Pack Qty.
LNCBS-3-01	0.188	4.8	1000
LNCBS-4-01	0.250	6.4	1000
LNCBS-6-01	0.375	9.5	1000
LNCBS-8-01	0.500	12.7	1000

Item No.	A In	A mm	Bulk Pack Qty.
LNCBS-10-01	0.625	15.9	1000
LNCBS-12-01	0.750	19.1	1000
LNCBS-14-01	0.875	22.2	1000



Request Info

1-800-453-1692

www.aboveboardelectronics.com

LOCKING CIRCUIT BOARD SUPPORTS

Buy One or Buy Bulk & SAVE

CBDLS Series Double Locking Support

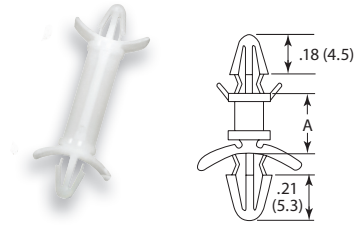

To Lock in Hole: .156 (4.0)
Panel Thickness: .062-.071 (1.6-1.8)

To Lock in Hole: .187 (4.8)
Panel Thickness: .031-.087 (0.8-2.2)

- Specifications:
- Material: Nylon 6/6
 - Color: Natural
 - Flame Class: UL94 V-2

Item No.	"A"		Bulk Pack Qty.
	In	mm	
CBDLS305A	0.157	4.0	1000
CBDLS310A	0.197	5.0	1000
CBDLS315A	0.250	6.4	1000
CBDLS320A	0.276	7.0	1000
CBDLS325A	0.375	9.5	1000
CBDLS330A	0.394	10.0	1000
CBDLS335A	0.500	12.7	1000
CBDLS340A	0.625	15.9	1000
CBDLS345A	0.748	19.0	1000

Item No.	"A"		Bulk Pack Qty.
	In	mm	
CBDLS350A	0.787	20.0	500
CBDLS355A	0.866	22.0	500
CBDLS360A	1.000	25.4	500
CBDLS365A	1.125	28.6	500
CBDLS370A	1.181	30.0	500
CBDLS375A	1.378	35.0	500
CBDLS380A	1.496	38.0	500
CBDLS385A	1.772	45.0	500

LCBSA-6 Locking Circuit Board Support High Temperature

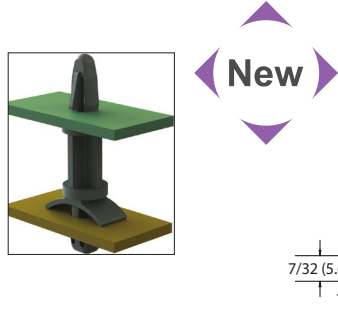

Top Hole: Snap-lock: .156 (4)
Panel Thickness: .093 (2.4)

Bottom Hole: Snap-lock: .187 (4.75)
Panel Thickness: .078 - .141 (1.98 - 3.58)

- Maximum temperature of 392°F (200°C)
- Extremely high strength
- Strong, dependable grip
- Color: Natural
- Material: Nylon 6/6



Item No.	"A"		Bulk Pack Qty.
	Material: UL94 V-2	Material: UL94	
LCBSA-6-3-01	LCBSA-6-3-19	3/16 (4.8)	1000
LCBSA-6-4-01	LCBSA-6-4-19	1/4 (6.4)	1000
LCBSA-6-5-01	LCBSA-6-5-19	5/16 (7.9)	1000
LCBSA-6-6-01	LCBSA-6-6-19	3/8 (9.5)	1000
LCBSA-6-7-01	LCBSA-6-7-19	7/16 (11.1)	1000
LCBSA-6-8-01	LCBSA-6-8-19	1/2 (12.7)	1000
LCBSA-6-10-01	LCBSA-6-10-19	5/8 (15.9)	1000
LCBSA-6-12-01	LCBSA-6-12-19	3/4 (19.1)	1000
LCBSA-6-14-01	LCBSA-6-14-19	7/8 (22.2)	1000
LCBSA-6-16-01	LCBSA-6-16-19	1 (25.4)	1000
LCBSA-6-18-01	LCBSA-6-18-19	1-1/8 (28.6)	1000
LCBSA-6-20-01	LCBSA-6-20-19	1-1/4 (31.7)	1000
LCBSA-6-22-01	LCBSA-6-22-19	1-3/8 (34.9)	1000

DLCBS3/CBDLS Double Locking Support

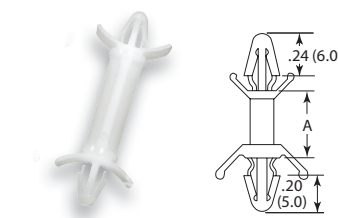

To Lock in Hole: .156 (4.0)
Panel Thickness: .047-.071 (1.2-1.8)

To Lock in Hole: .187 (4.8)
Panel Thickness: .031-.087 (0.8-2.2)

- Specifications:
- Material: Nylon 6/6
 - Color: Natural
 - Flame Class: UL94V-2

Item No.	"A"		Bulk Pack Qty.
	In	mm	
DLCBS3-3-01	0.187	4.8	1000
DLCBS3-4-01	0.250	6.4	1000
CBDLS215A	0.312	7.9	1000
DLCBS3-6-01	0.375	9.5	1000
DLCBS3-8-01	0.500	12.7	1000

Item No.	"A"		Bulk Pack Qty.
	In	mm	
DLCBS3-10-01	0.625	15.9	1000
CBDLS235A	0.750	19.1	1000
DLCBS3-14-01	0.875	22.2	1000
CBDLS245A	1.000	25.4	1000
CBDLS250A	1.125	28.6	1000

LCBS-7



Top Hole: Snap-lock: .156 (4)
Panel Thickness: .062 (1.57)

Bottom Hole: Snap-lock: .187 (4.75)
Panel Thickness: .031 - .078 (0.79 - 1.98)

- Specifications:
- Material: Nylon 6/6
 - Color: Natural



Item No.	"A"		Bulk Pack Qty.
	Material: UL94 V-2	Material: UL94 V-0	
LCBS-7-3-01	LCBS-7-3-19	3/16 (4.8)	1000
LCBS-7-4-01	LCBS-7-4-19	1/4 (6.4)	1000
LCBS-7-5-01	LCBS-7-5-19	5/16 (7.9)	1000
LCBS-7-6-01	LCBS-7-6-19	3/8 (9.5)	1000
LCBS-7-7-01	LCBS-7-7-19	7/16 (11.1)	1000
LCBS-7-8-01	LCBS-7-8-19	1/2 (12.7)	1000
LCBS-7-10-01	LCBS-7-10-19	5/8 (15.9)	1000
LCBS-7-12-01	LCBS-7-12-19	3/4 (19.1)	1000
LCBS-7-14-01	LCBS-7-14-19	7/8 (22.2)	1000
LCBS-7-16-01	LCBS-7-16-19	1 (25.4)	1000
LCBS-7-18-01	LCBS-7-18-19	1-1/8 (28.6)	1000
LCBS-7-20-01	LCBS-7-20-19	1-1/4 (31.8)	1000
LCBS-7-22-01	LCBS-7-22-19	1-3/8 (34.9)	1000

LCBS-8

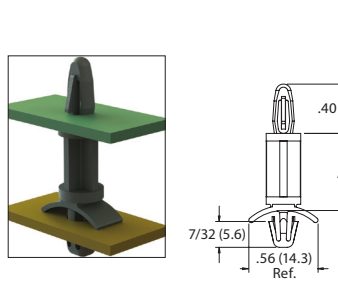

Top Hole: Snap-lock: .156 (4)
Panel Thickness: .062 (1.57)

Bottom Hole: Snap-lock: .187 (4.75)
Panel Thickness: .008 - .055 (0.2 - 1.4)

- Specifications:
- Material: UL94 V-2 Nylon 6/6
 - Color: Natural



Item No.	"A"		Bulk Pack Qty.
	Standoff Height		
LCBS-8-3-01	3/16 (4.8)	1000	
LCBS-8-4-01	1/4 (6.4)	1000	
LCBS-8-5-01	5/16 (7.9)	1000	
LCBS-8-6-01	3/8 (9.5)	1000	
LCBS-8-7-01	7/16 (11.1)	1000	
LCBS-8-8-01	1/2 (12.7)	1000	
LCBS-8-10-01	5/8 (15.9)	1000	

Item No.	"A"		Bulk Pack Qty.
	Standoff Height		
LCBS-8-12-01	3/4 (19.1)	1000	
LCBS-8-14-01	7/8 (22.2)	1000	
LCBS-8-16-01	1 (25.4)	1000	
LCBS-8-18-01	1-1/8 (28.6)	1000	
LCBS-8-20-01	1-1/4 (31.7)	1000	
LCBS-8-22-01	1-3/8 (34.9)	1000	

LOCKING CIRCUIT BOARD SUPPORTS



FLCBS Flexible Locking Circuit Board Support

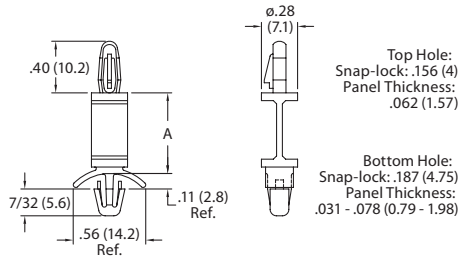
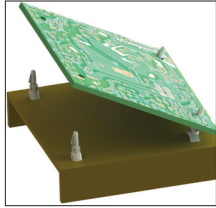

- Flexible spacer allows access to underside of board for maintenance and repair
- Material: UL94 V-2 Nylon 6/6
- Color: Natural

Item No.	"A" Standoff Height	Bulk Pack Qty.
FLCBS-6-01	3/8 (9.5)	1000
FLCBS-7-01	7/16 (11.1)	1000
FLCBS-8-01	1/2 (12.7)	1000
FLCBS-10-01	5/8 (15.9)	1000
FLCBS-12-01	3/4 (19.1)	1000
FLCBS-14-01	7/8 (22.2)	1000
FLCBS-16-01	1 (25.4)	1000
FLCBS-18-01	1-1/8 (28.6)	1000
FLCBS-20-01	1-1/4 (31.8)	1000
FLCBS-22-01	1-3/8 (34.9)	1000

DLCBS4 Dual Locking Circuit Board Support

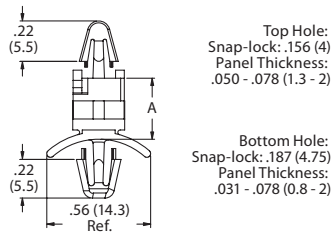

- Both ends lock by hand, no tools required
- Wings provide a tight fit to the boards and allow for various panel thicknesses
- Material: UL94 V-2, Nylon 6/6
- Color: Natural

Item No.	"A" Standoff Height	Bulk Pack Qty.
DLCBS4-3.5-01	.217 (5.5)	1000
DLCBS4-4-01	.240 (6.1)	1000
DLCBS4-5-01	.358 (9.1)	1000
DLCBS4-6-01	.488 (12.4)	1000
DLCBS4-8-01	.740 (18.8)	1000
DLCBS4-10-01	.862 (21.9)	1000

CBLSP Series Locking Support Posts

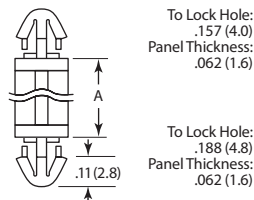
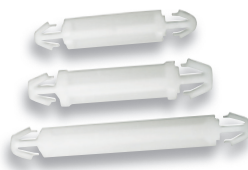

Specifications:

- Material: Nylon 6/6
- Color: Natural
- Flame Class: UL94 V-2

Features:

- Dual end locking feature will keep both panels secure once in place
- Eliminates screws, nuts and lock washers from mounting

Item No.	In	A mm	Bulk Pack Qty.
CBLSP205A	0.118	3.0	1000
CBLSP210A	0.157	4.0	1000
CBLSP215A	0.236	6.0	1000
CBLSP220A	0.315	8.0	1000
CBLSP225A	0.394	10.0	1000

Item No.	In	A mm	Bulk Pack Qty.
CBLSP230A	0.472	12.0	1000
CBLSP235A	0.551	14.0	1000
CBLSP240A	0.630	16.0	1000
CBLSP245A	0.709	18.0	1000

SP3 Series Support Post

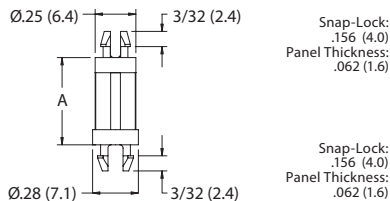
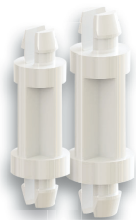

Specifications:

- Material: Nylon 6/6
- Color: Natural
- Flame Class: UL94 V-2

Item No.	In	A mm	Bulk Pack Qty.
SP3-3-01	0.188	4.8	1000
SP3-4-01	0.250	6.4	1000
SP3-6-01	0.375	9.5	1000
SP3-8-01	0.500	12.7	1000

Item No.	In	A mm	Bulk Pack Qty.
SP3-10-01	0.625	15.9	1000
SP3-12-01	0.750	19.1	1000
SP3-14-01	0.875	22.2	1000
SP3-16-01	1.000	25.4	1000

DLSP-3 Metric Dual Locking Support

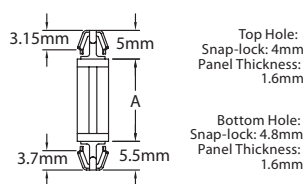
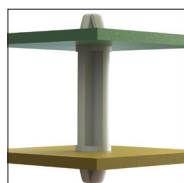

- Recess shoulder fits into PCB to provide greater stability
- Material: Nylon 6/6
- Color: Natural
- Flame Class: UL94 V-2

Item No.	"A" Standoff Height mm	Bulk Pack Qty.
DLSP-3-3M-01	3	1000
DLSP-3-4M-01	4	1000
DLSP-3-6M-01	6	1000
DLSP-3-8M-01	8	1000
DLSP-3-10M-01	10	1000

Item No.	"A" Standoff Height mm	Bulk Pack Qty.
DLSP-3-12M-01	12	1000
DLSP-3-14M-01	14	1000
DLSP-3-16M-01	16	1000
DLSP-3-18M-01	18	1000

LOCKING CIRCUIT BOARD SUPPORTS

Buy One or Buy Bulk & SAVE

LCBSA-3 Locking Circuit Board Support

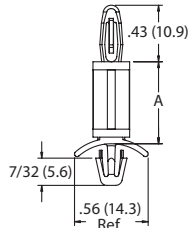
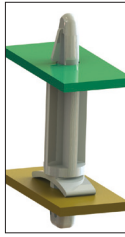

Top Hole:
Snap-lock: .156 (4)
Panel Thickness:
.093 (2.4)

Bottom Hole:
Snap-lock: .187 (4.75)
Panel Thickness:
.031 - .078 (0.79 - 1.98)

- Both ends lock by hand, no tools required
- Strong, dependable grip
- Material: UL94 V-2 Nylon 6/6
- Color: Natural



Item No.	"A" Standoff Height	Bulk Pack Qty.
LCBSA-3-3-01	3/16 (4.8)	1000
LCBSA-3-4-01	1/4 (6.4)	1000
LCBSA-3-5-01	5/16 (7.9)	1000
LCBSA-3-6-01	3/8 (9.5)	1000
LCBSA-3-7-01	7/16 (11.1)	1000
LCBSA-3-8-01	1/2 (12.7)	1000
LCBSA-3-10-01	5/8 (15.9)	1000

Item No.	"A" Standoff Height	Bulk Pack Qty.
LCBSA-3-12-01	3/4 (19.1)	1000
LCBSA-3-14-01	7/8 (22.2)	1000
LCBSA-3-16-01	1 (25.4)	1000
LCBSA-3-18-01	1-1/8 (28.6)	1000
LCBSA-3-20-01	1-1/4 (31.7)	1000
LCBSA-3-22-01	1-3/8 (34.9)	1000

LCBS-5 Locking Circuit Board Support

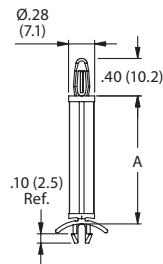
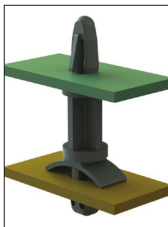

Top Hole:
Snap-lock: .156 (4)
Panel Thickness:
.062 (1.57)

Bottom Hole:
Snap-lock: .187 (4.75)
Panel Thickness:
.031 - .078 (0.79 - 1.98)

- Maximum temperature of 392°F (200°C)
- Extremely high strength
- Strong, dependable grip
- Material: UL94 V-2 Nylon 6/6
- Color: Natural



Item No.	"A" Standoff Height	Bulk Pack Qty.
LCBS-5-3-01	3/16 (4.8)	1000
LCBS-5-4-01	1/4 (6.4)	1000
LCBS-5-5-01	5/16 (7.9)	1000
LCBS-5-6-01	3/8 (9.5)	1000
LCBS-5-7-01	7/16 (11.1)	1000
LCBS-5-8-01	1/2 (12.7)	1000
LCBS-5-10-01	5/8 (15.9)	1000

Item No.	"A" Standoff Height	Bulk Pack Qty.
LCBS-5-12-01	3/4 (19.1)	1000
LCBS-5-14-01	7/8 (22.2)	1000
LCBS-5-16-01	1 (25.4)	1000
LCBS-5-18-01	1-1/8 (28.6)	1000
LCBS-5-20-01	1-1/4 (31.8)	1000
LCBS-5-22-01	1-3/8 (34.9)	1000

LCBS-HT Locking Circuit Board Support High Temperature

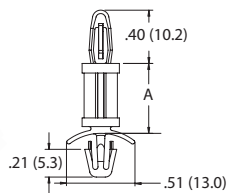

Top Hole:
Snap-lock: .156 (4.0)
Panel Thickness: .062 (1.57)

Bottom Hole:
Snap-lock: .187 (4.8)
Panel Thickness:
.031 - .078 (0.8 - 2.0)

Specifications:

- Material: PEI
- Color: Black
- Flame Class: UL94 V-0

Features:

- Temperature rating up to 392°F (200°C)



Item No.	A		Bulk Pack Qty.
	In	mm	
LCBS-3-HT	0.188	4.8	1000
LCBS-4-HT	0.250	6.4	1000
LCBS-5-HT	0.313	7.9	1000
LCBS-6-HT	0.375	9.5	1000
LCBS-7-HT	0.438	11.1	1000
LCBS-8-HT	0.500	12.7	1000
LCBS-10-HT	0.625	15.9	1000

Item No.	A		Bulk Pack Qty.
	In	mm	
LCBS-12-HT	0.750	19.1	1000
LCBS-14-HT	0.875	22.2	1000
LCBS-16-HT	1.000	25.4	1000
LCBS-18-HT	1.125	28.6	1000
LCBS-20-HT	1.250	31.8	1000
LCBS-22-HT	1.375	34.9	1000

CBL Series Locking Support

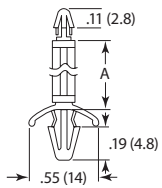

To Lock in Hole:
.137 (3.5)
Panel Thickness:
.047-.067 (1.2-1.7)

To Lock in Hole:
.187 (4.8)
Panel Thickness:
.031-.086 (0.8-2.2)

Specifications:

- Material: Nylon 6/6
- Color: Natural
- Flame Class: UL94 V-2

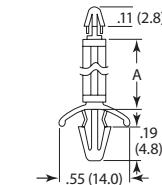

To Lock in Hole:
.118 (3.0)
Panel Thickness:
.047-.067 (1.2-1.7)

To Lock in Hole:
.187 (4.8)
Panel Thickness:
.031-.086 (0.8-2.2)

Item No.	A		Bulk Pack Qty.
	In	mm	
CBL105A	0.125	3.2	1000
CBL110A	0.197	5.0	1000
CBL115A	0.248	6.3	1000
CBL120A	0.315	8.0	1000
CBL125A	0.394	10.0	1000

Item No.	A		Bulk Pack Qty.
	In	mm	
CBL130A	0.472	12.0	1000
CBL135A	0.551	14.0	1000
CBL140A	0.630	16.0	1000
CBL145A	0.709	18.0	1000
CBL150A	0.984	25.0	1000

Item No.	A		Bulk Pack Qty.
	In	mm	
CBL205A	0.125	3.2	1000
CBL210A	0.187	4.8	1000
CBL215A	0.248	6.3	1000
CBL220A	0.315	8.0	1000
CBL225A	0.394	10.0	1000

Item No.	A		Bulk Pack Qty.
	In	mm	
CBL230A	0.472	12.0	1000
CBL235A	0.551	14.0	1000
CBL240A	0.630	16.0	1000
CBL245A	0.709	18.0	1000
CBL250A	0.984	25.0	1000

DLCBS Series Double Locking Support

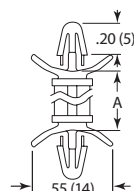

To Lock in Hole:
.156 (4.0)
Panel Thickness:
.031-.078 (0.8-2.0)

To Lock in Hole:
.156 (4.0)
Panel Thickness:
.031-.078 (0.8-2.0)

Specifications:

- Material: Nylon 6/6
- Color: Natural
- Flame Class: UL94 V-2

Item No.	A		Bulk Pack Qty.
	In	mm	
DLCBS-3-01	0.187	4.8	1000
DLCBS-4-01	0.250	6.4	1000
DLCBS-6-01	0.375	9.5	1000
DLCBS-8-01	0.500	12.7	1000

Item No.	A		Bulk Pack Qty.
	In	mm	
DLCBS-10-01	0.625	15.9	1000
DLCBS-12-01	0.750	19.1	1000
DLCBS-14-01	0.875	22.2	1000

LOCKING CIRCUIT BOARD SUPPORTS

CBDLs Series Double Locking Support

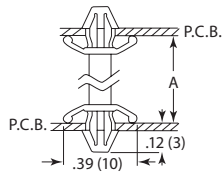

Specifications:

- Material: Nylon 6/6
- Color: Natural
- Flame Class: UL94 V-2

Item No.	A		Bulk Pack Qty.
	In	mm	
CBDLs105A	0.236	6.0	1000
CBDLs110A	0.315	8.0	1000
CBDLs115A	0.394	10.0	1000
CBDLs120A	0.472	12.0	1000
CBDLs125A	0.512	13.0	1000

Item No.	A		Bulk Pack Qty.
	In	mm	
CBDLs130A	0.551	14.0	1000
CBDLs135A	0.630	16.0	1000
CBDLs140A	0.661	16.8	1000
CBDLs145A	0.709	18.0	1000
CBDLs150A	0.787	20.0	1000

SP1 Support Post

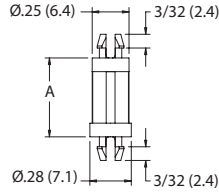

Snap-Lock:
.156 (4.0)
Panel Thickness:
.062 (1.6)

Snap-Lock:
.156 (4.0)
Panel Thickness:
.062 (1.6)

Specifications:

- Material: Nylon 6/6
- Color: Natural
- Flame Class: UL94 V-2

Item No.	A		Bulk Pack Qty.
	In	mm	
SP1-3-01	0.188	4.8	1000
SP1-4-01	0.250	6.4	1000
SP1-6-01	0.375	9.5	1000
SP1-8-01	0.500	12.7	1000

Item No.	A		Bulk Pack Qty.
	In	mm	
SP1-10-01	0.625	15.9	1000
SP1-12-01	0.750	19.1	1000
SP1-14-01	0.875	22.2	1000
SP1-16-01	1.000	25.4	1000



CBLSP/DLSP-1 Locking Support Posts

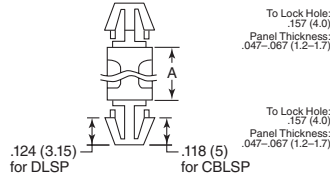

Features:

- Material: Nylon 6/6
- Color: Natural
- Flame Class: UL94 V-2
- Dual end locking feature will keep both panels secure once in place
- Eliminates screws, nuts and lock washers from mounting

Item No.	A		Bulk Pack Qty.
	In	mm	
DLSP-1-3M-01	0.118	3.0	1000
CBLSP010A	0.138	3.5	2000
DLSP-1-4M-01	0.157	4.0	1000
CBLSP020A	0.197	5.0	2000
DLSP-1-6M-01	0.236	6.0	1000
CBLSP030A	0.250	6.4	1000
DLSP-1-8M-01	0.315	8.0	1000
DLSP-1-10M-01	0.394	10.0	1000
CBLSP045A	0.413	10.5	1000
CBLSP050A	0.453	11.5	1000
DLSP-1-12M-01	0.472	12.0	1000
CBLSP060A	0.500	12.7	1000
DLSP-1-14M-01	0.551	14.0	1000
DLSP-1-16M-01	0.625	15.9	1000

Item No.	A		Bulk Pack Qty.
	In	mm	
DLSP-1-18M-01	0.709	18.0	1000
CBLSP080A	0.748	19.0	1000
CBLSP085A	0.787	20.0	1000
CBLSP090A	0.984	25.0	1000
CBLSP095A	1.063	27.0	1000
CBLSP100A	1.181	30.0	1000
CBLSP105A	1.339	34.0	1000
CBLSP110A	2.717	69.0	500
CBLSP115A	2.803	71.2	500
CBLSP120A	2.835	72.0	500
CBLSP125A	2.921	74.2	500
CBLSP130A	3.150	80.0	500
DLSP-1-25M-01	0.984	25.0	1000
DLSP-1-30M-01	1.181	30.0	1000

MSPS Mini Support Post

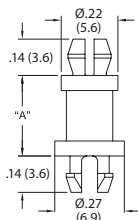
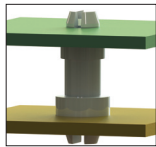

Top Hole:
Snap-fit: .156 (4)
Panel Thickness:
.062 (1.57)

Bottom Hole:
Snap-lock: .156 (4)
Panel Thickness:
.062 (1.57)

- Board mount head is releasable
- Chassis mount head locks permanently
- Shoulder added for locating purposes to facilitate automated assembly
- Material: UL94 V-2, Nylon 6/6
- Color: Natural

Item No.	"A"	Bulk Pack Qty.
MSPS-3-01	3/16 (4.8)	1000
MSPS-4-01	1/4 (6.4)	1000
MSPS-5-01	5/16 (7.9)	1000
MSPS-6-01	3/8 (9.5)	1000
MSPS-7-01	7/16 (11.1)	1000
MSPS-8-01	1/2 (12.7)	1000
MSPS-10-01	5/8 (15.9)	1000
MSPS-11-01	11/16 (17.5)	1000
MSPS-12-01	3/4 (19.1)	1000
MSPS-14-01	7/8 (22.2)	1000

DLCBS7 Dual Locking Circuit Board Support

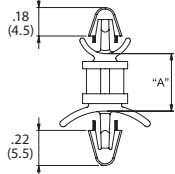

Top Hole:
Snap-lock: .156 (4)
Panel Thickness:
.062 (1.6)

Bottom Hole:
Snap-lock: .156 (4)
Panel Thickness:
.062 (1.6)



- Both ends lock by hand, no tools required
- "Wings" provide a tight fit to the boards and allow for various panel thicknesses
- Material: UL94 V-2, Nylon 6/6
- Color: Natural

Item No.	"A" Standoff Height	Bulk Pack Qty.
DLCBS7-3-01	3/16 (4.8)	1000
DLCBS7-4-01	1/4 (6.4)	1000
DLCBS7-5-01	5/16 (7.9)	1000
DLCBS7-6-01	3/8 (9.5)	1000
DLCBS7-7-01	7/16 (11.1)	1000

Item No.	"A" Standoff Height	Bulk Pack Qty.
DLCBS7-8-01	1/2 (12.7)	1000
DLCBS7-9-01	9/16 (14.3)	1000
DLCBS7-10-01	5/8 (15.9)	1000
DLCBS7-12-01	3/4 (19.1)	1000



BHDL Blind Hole Dual Locking Circuit Board Support

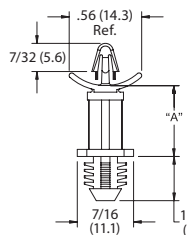
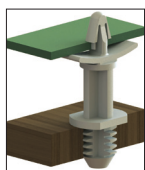

Top Hole:
Snap-lock: .156 (4)
Panel Thickness:
.031 - .078 (0.79 - 1.98)

Bottom Hole:
Press-fit: .312 (7.92)
Panel Thickness:
1/4 (6.4) Min.

- Fir-tree mount is flexible and will lock into round, threaded, punched or drilled blind holes
- Material: UL94 V-2, Nylon 6/6
- Color: Natural

Item No.	"A" Standoff Height	Bulk Pack Qty.
BHDL-4-01	1/4 (6.4)	1000
BHDL-6-01	3/8 (9.5)	1000
BHDL-8-01	1/2 (12.7)	1000

Item No.	"A" Standoff Height	Bulk Pack Qty.
BHDL-10-01	5/8 (15.9)	1000
BHDL-12-01	3/4 (19.1)	1000
BHDL-14-01	7/8 (22.2)	1000



LOCKING CIRCUIT BOARD SUPPORTS

Buy One or Buy Bulk & SAVE

BHL Blind Hole Locking Support

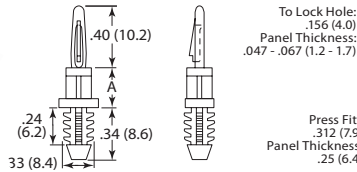
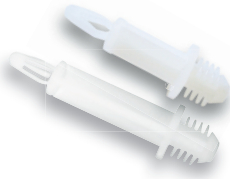

Specifications:

- Material: Nylon 6/6
- Color: Natural
- Flame Class: UL94 V-2



Item No.	A		Bulk Pack Qty.
	In	mm	
BHL-3-01	0.187	4.8	1000
BHL-4-01	0.250	6.4	1000
BHL-6-01	0.375	9.5	1000
BHL-7-01	0.437	11.1	1000
BHL-8-01	0.500	12.7	1000

Item No.	A		Bulk Pack Qty.
	In	mm	
BHL-10-01	0.625	15.9	1000
BHL-12-01	0.750	19.1	1000
BHL-14-01	0.875	22.2	1000
CBBHS045A	1.000	25.4	1000

DLMSP Mini Support Post

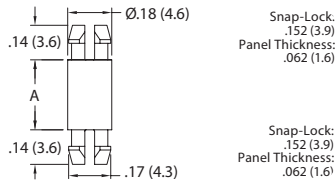

Specifications:

- Material: Nylon 6/6
- Color: Natural
- Flame Class: UL94 V-2



Item No.	A		Bulk Pack Qty.
	In	mm	
DLMSP-2-01	0.125	3.2	1000
DLMSP-3-01	0.188	4.8	1000
DLMSP-4-01	0.250	6.4	1000
DLMSP-5-01	0.313	7.9	1000
DLMSP-6-01	0.375	9.5	1000
DLMSP-7-01	0.438	11.1	1000
DLMSP-8-01	0.500	12.7	1000
DLMSP-9-01	0.563	14.3	1000

Item No.	A		Bulk Pack Qty.
	In	mm	
DLMSP-10-01	0.625	15.9	1000
DLMSP-12-01	0.750	19.1	1000
DLMSP-14-01	0.875	22.2	1000
DLMSP-16-01	1.000	25.4	1000
DLMSP-18-01	1.125	28.6	1000
DLMSP-20-01	1.250	31.8	1000
DLMSP-22-01	1.375	34.9	1000
DLMSP-24-01	1.500	38.1	1000

CBLSP Locking Support Posts

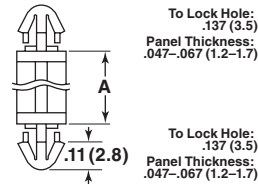
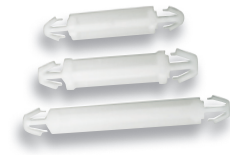

Specifications:

- Material: Nylon 6/6
- Color: Natural
- Flame Class: UL94 V-2

Features:

- Dual end locking feature will keep both panels secure once in place
- Eliminates screws, nuts and lock washers from mounting

Item No.	A		Bulk Pack Qty.
	In	mm	
CBLSP305A	0.098	2.5	2000
CBLSP310A	0.118	3.0	2000
CBLSP315A	0.138	3.5	2000
CBLSP320A	0.157	4.0	2000
CBLSP325A	0.177	4.5	2000
CBLSP330A	0.197	5.0	2000
CBLSP335A	0.217	5.5	1000
CBLSP340A	0.236	6.0	1000

Item No.	A		Bulk Pack Qty.
	In	mm	
CBLSP345A	0.250	6.4	1000
CBLSP350A	0.276	7.0	1000
CBLSP355A	0.315	8.0	1000
CBLSP360A	0.354	9.0	1000
CBLSP365A	0.394	10.0	1000
CBLSP370A	0.433	11.0	1000
CBLSP375A	0.472	12.0	1000
CBLSP380A	0.591	15.0	1000

CBDLS Series Double Locking Support

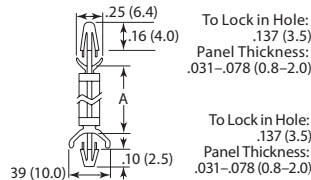

Specifications:

- Material: Nylon 6/6
- Color: Natural
- Flame Class: UL94 V-2

Item No.	A		Bulk Pack Qty.
	In	mm	
CBDSL605A	0.125	3.2	2000
CBDSL610A	0.157	4.0	2000
CBDSL615A	0.187	4.8	1000
CBDSL620A	0.250	6.4	1000
CBDSL625A	0.276	7.0	1000
CBDSL630A	0.315	8.0	1000
CBDSL635A	0.378	9.6	1000

Item No.	A		Bulk Pack Qty.
	In	mm	
CBDSL640A	0.441	11.2	1000
CBDSL645A	0.500	12.7	1000
CBDSL650A	0.551	14.0	1000
CBDSL655A	0.630	16.0	1000
CBDSL660A	0.709	18.0	1000
CBDSL665A	0.750	19.1	1000

DLCBS5 Dual Locking Circuit Board Support

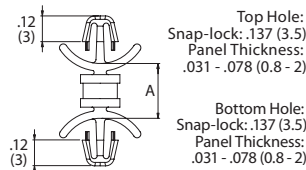

- Both ends lock by hand, no tools required
- Wings provide a tight fit to the boards and allow for various panel thicknesses Material: UL94 V-2, Nylon 6/6
- Color: Natural



Item No.	"A" Standoff Height		Bulk Pack Qty.
	mm		
DLCBS5-3-01	3/16 (4.8)	1000	
DLCBS5-4-01	1/4 (6.4)	1000	
DLCBS5-5-01	5/16 (7.9)	1000	
DLCBS5-6-01	3/8 (9.5)	1000	

Item No.	"A" Standoff Height		Bulk Pack Qty.
	mm		
DLCBS5-7-01	7/16 (11.1)	1000	
DLCBS5-8-01	1/2 (12.7)	1000	
DLCBS5-9-01	9/16 (14.3)	1000	

DLCBS6 Dual Locking Circuit Board Support

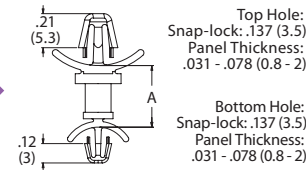

- Both ends lock by hand, no tools required
- "Wings" provide a tight fit to the boards and allow for various panel thicknesses
- Material: UL94 V-2 Nylon 6/6
- Color: Natural



Item No.	"A" Standoff Height		Bulk Pack Qty.
	mm		
DLCBS6-3-01	3/16 (4.8)	1000	
DLCBS6-4-01	1/4 (6.4)	1000	
DLCBS6-5-01	5/16 (7.9)	1000	
DLCBS6-6-01	3/8 (9.5)	1000	

Item No.	"A" Standoff Height		Bulk Pack Qty.
	mm		
DLCBS6-7-01	7/16 (11.1)	1000	
DLCBS6-8-01	1/2 (12.7)	1000	
DLCBS6-9-01	9/16 (14.3)	1000	
DLCBS6-10-01	5/8 (15.9)	1000	

LOCKING CIRCUIT BOARD SUPPORTS



MDLSP2 Metric Mini Dual Locking Support Post

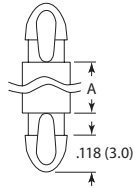

To Lock Hole:
.137 (3.5)
Panel Thickness:
.062 (1.6)

To Lock Hole:
.137 (3.5)
Panel Thickness:
.062 (1.6)

Specifications:

- Material: Nylon 6/6
- Color: Natural
- Flame Class: UL94 V-2



Item No.	A		Bulk Pack Qty.
	In	mm	
MDLSP2-02M-01	0.078	2.0	1000
MDLSP2-03M-01	0.118	3.0	1000
MDLSP2-04M-01	0.156	4.0	1000
MDLSP2-05M-01	0.197	5.0	1000
MDLSP2-06M-01	0.236	6.0	1000
MDLSP2-07M-01	0.276	7.0	1000
MDLSP2-08M-01	0.314	8.0	1000

Item No.	A		Bulk Pack Qty.
	In	mm	
MDLSP2-10M-01	0.394	10.0	1000
MDLSP2-12M-01	0.472	12.0	1000
MDLSP2-14M-01	0.551	14.0	1000
MDLSP2-16M-01	0.630	16.0	1000
MDLSP2-18M-01	0.709	18.0	1000
MDLSP2-20M-01	0.787	20.0	1000
MDLSP2-22M-01	0.866	22.0	1000

LCBSM Locking Support - Mini

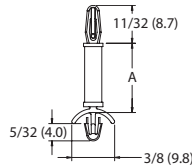

Top Hole:
Snap-Lock: .125
Panel Thickness:
.062 (1.57)

Bottom Hole:
Snap-Lock: .125
Panel Thickness:
.031 - .078 (0.8 - 2.0)

Specifications:

- Material: Nylon 6/6
- Color: Natural
- Flame Class: UL94 V-2



Item No.	A		Bulk Pack Qty.
	In	mm	
LCBSM-2-01	0.125	3.2	1000
LCBSM-3-01	0.188	4.8	1000
LCBSM-4-01	0.250	6.4	1000
LCBSM-5-01	0.313	7.9	1000
LCBSM-6-01	0.375	9.5	1000

Item No.	A		Bulk Pack Qty.
	In	mm	
LCBSM-7-01	0.438	11.1	1000
LCBSM-8-01	0.500	12.7	1000
LCBSM-9-01	0.563	14.3	1000
LCBSM-10-01	0.625	15.9	1000

LMSP Locking Support

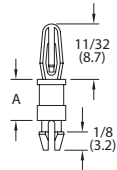
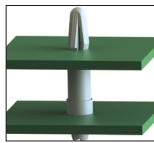

Top Hole:
Snap-lock: .125 (3.2)
Panel Thickness: .062 (1.57)

Bottom Hole:
Snap-lock: .125 (3.2)
Panel Thickness: .062 (1.6)

Specifications:

- Material: Nylon 6/6
- Color: Natural
- Flame Class: UL94 V-2



Item No.	A		Bulk Pack Qty.
	In	mm	
LMSP-2-01	0.125	3.2	1000
LMSP-3-01	0.188	4.8	1000
LMSP-4-01	0.250	6.4	1000
LMSP-5-01	0.313	7.9	1000
LMSP-6-01	0.375	9.5	1000
LMSP-7-01	0.438	11.1	1000

Item No.	A		Bulk Pack Qty.
	In	mm	
LMSP-8-01	0.500	12.7	1000
LMSP-9-01	0.563	14.3	1000
LMSP-10-01	0.625	15.9	1000
LMSP-11-01	0.688	17.5	1000
LMSP-12-01	0.750	19.1	1000
LMSP-14-01	0.875	22.2	1000

- Both ends lock by hand, no tools required
- Strong, dependable grip

DLCBSM Double Locking Support

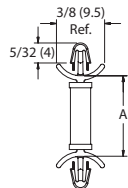

Top Hole:
Snap-Lock: .125
Panel Thickness: .031 - .078 (0.8 - 2.0)

Bottom Hole:
Snap-Lock: .125
Panel Thickness: .031 - .078 (0.8 - 2.0)

Specifications:

- Material: Nylon 6/6
- Color: Natural
- Flame Class: UL94 V-2



Item No.	A		Bulk Pack Qty.
	In	mm	
DLCBSM-3-01	0.188	4.8	1000
DLCBSM-4-01	0.250	6.4	1000
DLCBSM-5-01	0.313	7.9	1000
DLCBSM-6-01	0.375	9.5	1000

Item No.	A		Bulk Pack Qty.
	In	mm	
DLCBSM-7-01	0.438	11.1	1000
DLCBSM-8-01	0.500	12.7	1000
DLCBSM-9-01	0.563	14.3	1000
DLCBSM-10-01	0.625	15.9	1000

DLMSPM Stud Fitting Support

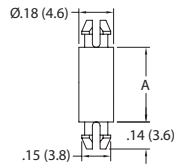
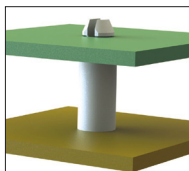

Snap-Lock:
.125 (3.2)
Panel Thickness:
.062 (1.6)

Snap-Lock:
.125 (3.2)
Panel Thickness:
.062 (1.6)

Specifications:

- Material: Nylon 6/6
- Color: Natural
- Flame Class: UL94 V-2



Item No.	A		Bulk Pack Qty.
	In	mm	
DLMSPM-2-01	0.125	3.2	1000
DLMSPM-3-01	0.188	4.8	1000
DLMSPM-4-01	0.250	6.4	1000
DLMSPM-5-01	0.313	7.9	1000
DLMSPM-6-01	0.375	9.5	1000
DLMSPM-7-01	0.438	11.1	1000
DLMSPM-8-01	0.500	12.7	1000
DLMSPM-9-01	0.563	14.3	1000
DLMSPM-10-01	0.625	15.9	1000

Item No.	A		Bulk Pack Qty.
	In	mm	
DLMSPM-12-01	0.750	19.1	1000
DLMSPM-13-01	0.813	20.6	1000
DLMSPM-14-01	0.875	22.2	1000
DLMSPM-16-01	1.000	25.4	1000
DLMSPM-18-01	1.125	28.6	1000
DLMSPM-20-01	1.250	31.8	1000
DLMSPM-22-01	1.375	34.9	1000
DLMSPM-24-01	1.500	38.1	1000

CLCBST Cupped Locking Circuit Board Support

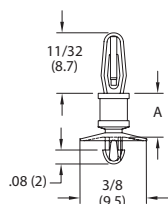
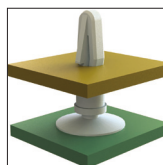

Top Hole:
Snap-lock: .100 (2.54)
Panel Thickness: .062 (1.57)

Bottom Hole:
Snap-lock: .100 (2.54)
Panel Thickness: .062 (1.57)

- Material: UL94 V-2
- Nylon 6/6
- Color: Natural

- Cupped base covers hole completely
- Low profile



Item No.	"A" Standoff Height		Bulk Pack Qty.
	In	mm	
CLCBST-2-01	1/8 (3.2)	1,000	
CLCBST-3-01	3/16 (4.8)	1,000	
CLCBST-4-01	1/4 (6.4)	1,000	
CLCBST-5-01	5/16 (7.9)	1,000	
CLCBST-6-01	3/8 (9.5)	1,000	

Item No.	"A" Standoff Height		Bulk Pack Qty.
	In	mm	
CLCBST-7-01	7/16 (11.1)	1,000	
CLCBST-8-01	1/2 (12.7)	1,000	
CLCBST-9-01	9/16 (14.3)	1,000	
CLCBST-10-01	5/8 (15.9)	1,000	

LOCKING CIRCUIT BOARD SUPPORTS

Buy One or Buy Bulk & SAVE

LCBST Locking Support

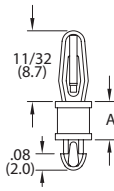

Top Hole:
Snap-lock: .125 (4.0)
Panel Thickness: .062 (1.57)

Bottom Hole:
Snap-lock: .100 (2.54)
Panel Thickness: .064 (1.63) Max

Specifications:

- Material: Nylon 6/6
- Color: Natural
- Flame Class: UL94 V-2



Item No.	"A"		Bulk Pack Qty.
	In	mm	
LCBST-2-01	0.125	3.2	1000
LCBST-3-01	0.188	4.8	1000
LCBST-4-01	0.250	6.4	1000
LCBST-5-01	0.313	7.9	1000
LCBST-6-01	0.375	9.5	1000

Item No.	"A"		Bulk Pack Qty.
	In	mm	
LCBST-7-01	0.438	11.1	1000
LCBST-8-01	0.500	12.7	1000
LCBST-9-01	0.563	14.3	1000
LCBST-10-01	0.625	15.9	1000

DLCBSAT Dual Locking Circuit Board Support, Arrowhead

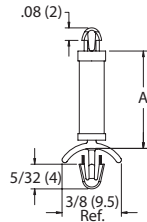
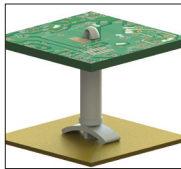

Top Hole:
Snap-lock: .100 (2.54)
Panel Thickness: .064 (1.63) Max

Bottom Hole:
Snap-lock: .125 (3.18)
Panel Thickness: .031-.078 (0.79-1.98)

- Material: UL94 V-2 Nylon 6/6
- Color: Natural

- Teardrop style nose eases insertion and increases holding power
- Low profile on top hole



Item No.	"A" Standoff Height	Bulk Pack Qty.
DLCBSAT-3-01	3/16 (4.8)	1000
DLCBSAT-4-01	1/4 (6.4)	1000
DLCBSAT-5-01	5/16 (7.9)	1000
DLCBSAT-6-01	3/8 (9.5)	1000

Item No.	"A" Standoff Height	Bulk Pack Qty.
DLCBSAT-8-01	1/2 (12.7)	1000
DLCBSAT-9-01	9/16 (14.3)	1000
DLCBSAT-10-01	5/8 (15.9)	1000

DLCBST Dual Locking Circuit Board Support, Teardrop

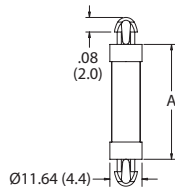

Snap-Lock: .100 (2.54)
Panel Thickness: .064 (1.6) Max

Snap-Lock: .100 (4.0)
Panel Thickness: .064 (1.6) Max

Specifications:

- Material: Nylon 6/6
- Color: Natural
- Flame Class: UL94 V-2



Item No.	"A"		Bulk Pack Qty.
	In	mm	
DLCBST-1-01	0.063	1.6	1000
DLCBST-2-01	0.125	3.2	1000
DLCBST-3-01	0.188	4.8	1000
DLCBST-4-01	0.250	6.4	1000
DLCBST-5-01	0.313	7.9	1000

Item No.	"A"		Bulk Pack Qty.
	In	mm	
DLCBST-6-01	0.375	9.5	1000
DLCBST-7-01	0.438	11.1	1000
DLCBST-8-01	0.500	12.7	1000
DLCBST-9-01	0.563	14.3	1000
DLCBST-10-01	0.625	15.9	1000

CDLCBST Cupped Dual Locking Circuit Board Support

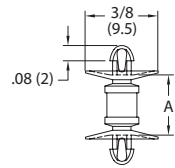

Top Hole:
Snap-lock: .100 (2.54)
Panel Thickness: .062 (1.57)

Bottom Hole:
Snap-lock: .100 (2.54)
Panel Thickness: .062 (1.57)

- Teardrop style nose eases insertion and increases holding power
- Cupped base completely covers the hole
- Material: UL94 V-2 Nylon 6/6
- Color: Natural



Item No.	"A" Standoff Height	Bulk Pack Qty.
CDLCBST-4-01	1/4 (6.4)	1000
CDLCBST-5-01	5/16 (7.9)	1000
CDLCBST-6-01	3/8 (9.5)	1000
CDLCBST-7-01	7/16 (11.1)	1000
CDLCBST-8-01	1/2 (12.7)	1000
CDLCBST-9-01	9/16 (14.3)	1000
CDLCBST-10-01	5/8 (15.9)	1000

CBLS Series Locking Support

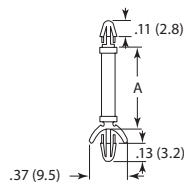

To Lock in Hole:
.118 (3.0)
Panel Thickness: .047-.067 (1.2-1.7)

To Lock in Hole:
.118 (3.0)
Panel Thickness: .031-.078 (0.8-2.0)

Specifications:

- Material: Nylon 6/6
- Color: Natural
- Flame Class: UL94 V-2

Item No.	"A"		Bulk Pack Qty.
	In	mm	
CBLS305A	0.125	3.2	1000
CBLS310A	0.187	4.8	1000
CBLS315A	0.250	6.4	1000
CBLS320A	0.312	7.9	1000
CBLS325A	0.375	9.5	1000

Item No.	"A"		Bulk Pack Qty.
	In	mm	
CBLS330A	0.437	11.1	1000
CBLS335A	0.500	12.7	1000
CBLS340A	0.562	14.3	1000
CBLS345A	0.625	15.9	1000
CBLS350A	0.748	19.0	1000

CBDLs Series Double Locking Support

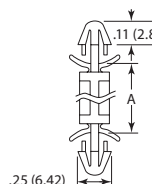

To Lock in Hole:
.118 (3.0)
Panel Thickness: .047-.078 (1.2-2.0)

To Lock in Hole:
.118 (3.0)
Panel Thickness: .047-.078 (1.2-2.0)

Specifications:

- Material: Nylon 6/6
- Color: Natural
- Flame Class: UL94 V-2

Item No.	"A"		Bulk Pack Qty.
	In	mm	
CBDLs505A	0.125	3.2	1000
CBDLs510A	0.197	5.0	1000
CBDLs515A	0.250	6.4	1000
CBDLs520A	0.276	7.0	1000
CBDLs525A	0.315	8.0	1000
CBDLs530A	0.375	9.5	1000
CBDLs535A	0.441	11.2	1000

Item No.	"A"		Bulk Pack Qty.
	In	mm	
CBDLs540A	0.472	12.0	1000
CBDLs545A	0.591	15.0	1000
CBDLs550A	0.630	16.0	1000
CBDLs555A	0.669	17.0	1000
CBDLs560A	0.787	20.0	1000
CBDLs565A	0.866	22.0	1000
CBDLs570A	1.000	25.4	1000

LOCKING & NON-LOCKING CIRCUIT BOARD SUPPORTS

CBLS Series Locking Support

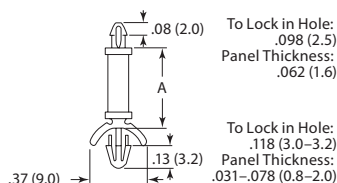

Specifications:

- Material: Nylon 6/6
- Color: Natural
- Flame Class: UL94 V-2

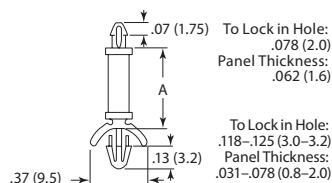

Item No.	A		Bulk Pack Qty.
	In	mm	
CBLS405A	0.125	3.2	1000
CBLS410A	0.187	4.8	1000
CBLS415A	0.250	6.4	1000
CBLS420A	0.312	7.9	1000
CBLS425A	0.375	9.5	1000

Item No.	A		Bulk Pack Qty.
	In	mm	
CBLS430A	0.437	11.1	1000
CBLS435A	0.500	12.7	1000
CBLS440A	0.562	14.3	1000
CBLS445A	0.625	15.9	1000

Item No.	A		Bulk Pack Qty.
	In	mm	
CBLS505A	0.125	3.2	1000
CBLS510A	0.187	4.8	1000
CBLS515A	0.250	6.4	1000
CBLS520A	0.312	7.9	1000
CBLS525A	0.375	9.5	1000

Item No.	A		Bulk Pack Qty.
	In	mm	
CBLS530A	0.437	11.1	1000
CBLS535A	0.500	12.7	1000
CBLS540A	0.562	14.3	1000
CBLS545A	0.625	15.9	1000

MDLSP Series Dual Locking Mini Support Post

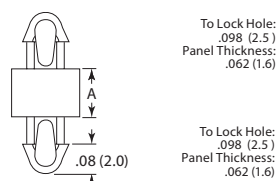

Specifications:

- Low Profile
- Material: Nylon 6/6
- Color: Natural
- Flame Class: UL94 V-2

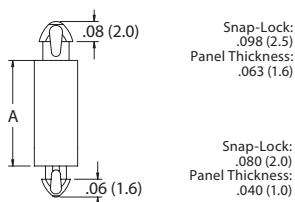

Item No.	A		Bulk Pack Qty.
	In	mm	
MDLSP1-02M-01	0.078	2.0	1000
MDLSP1-03M-01	0.118	3.0	1000
MDLSP1-04M-01	0.156	4.0	1000
MDLSP1-05M-01	0.197	5.0	1000
MDLSP1-06M-01	0.236	6.0	1000
MDLSP1-07M-01	0.276	7.0	1000
MDLSP1-08M-01	0.314	8.0	1000
CBMLSP040A	0.334	8.5	2000

Item No.	A		Bulk Pack Qty.
	In	mm	
MDLSP1-09M-01	0.354	9.0	1000
MDLSP1-10M-01	0.394	10.0	1000
MDLSP1-12M-01	0.472	12.0	1000
MDLSP1-14M-01	0.551	14.0	1000
MDLSP1-16M-01	0.630	16.0	1000
MDLSP1-18M-01	0.709	18.0	1000
MDLSP1-20M-01	0.787	20.0	1000
MDLSP1-22M-01	0.866	22.0	1000



LCBS-4 Non-Locking Circuit Board Support

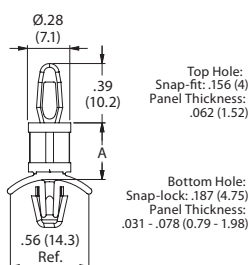
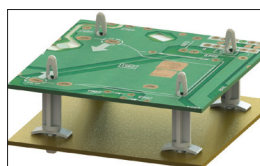

- PC board is removable
- Material: Nylon 6/6
- Color: Natural

Material: UL94 V-2	Item No.	Material: UL94 V-0	"A" Standoff Height	Bulk Pack Qty.
LCBS-4-4-01	LCBS-4-4-19	1/4 (6.4)	1000	
LCBS-4-5-01	LCBS-4-5-19	5/16 (7.9)	1000	
LCBS-4-6-01	LCBS-4-6-19	3/8 (9.5)	1000	
LCBS-4-7-01	LCBS-4-7-19	7/16 (11.1)	1000	
LCBS-4-8-01	LCBS-4-8-19	1/2 (12.7)	1000	
LCBS-4-10-01	LCBS-4-10-19	5/8 (15.9)	1000	
LCBS-4-12-01	LCBS-4-12-19	3/4 (19.1)	1000	
LCBS-4-14-01	LCBS-4-14-19	7/8 (22.2)	1000	
LCBS-4-16-01	LCBS-4-16-19	1 (25.4)	1000	
LCBS-4-18-01	LCBS-4-18-19	1-1/8 (28.6)	1000	
LCBS-4-20-01	LCBS-4-20-19	1-1/4 (31.8)	1000	
LCBS-4-22-01	LCBS-4-22-19	1-3/8 (34.9)	1000	



CBS Releasable Supports



- ### Specifications:
- Material: Nylon 6/6
 - Color: Natural
 - Flame Class: UL94 V-2

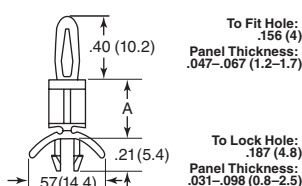

Features:

- Spring end locks or releases in order to remove support and allow for repairs
- Eliminates screws, nuts and lock washers from mounting

Item No.	A		Bulk Pack Qty.
	In	mm	
CBS-3-01	0.187	4.8	1000
CBS-4-01	0.250	6.4	1000
CBS-6-01	0.375	9.5	1000
CBS-8-01	0.500	12.7	1000

Item No.	A		Bulk Pack Qty.
	In	mm	
CBS-10-01	0.625	15.9	1000
CBS-12-01	0.750	19.1	1000
CBS-14-01	0.875	22.2	1000



NON-LOCKING & REVERSE MOUNT CIRCUIT BOARD SUPPORTS

Buy One or
Buy Bulk & SAVE

CBMSP Series Mini Support Post

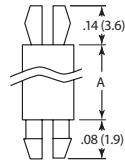

To Fit Hole:
.157 (4.0)
Panel Thickness:
.047 - .066 (1.2 - 1.7)

To Fit Hole:
.157 (4.0)
Panel Thickness:
.047 - .066 (1.2 - 1.7)

Specifications:

- Material: Nylon 6/6
- Color: Natural
- Flame Class: UL94 V-2

Item No.	A		Bulk Pack Qty.
	In	mm	
CBMSP210A	0.157	4.0	1000
CBMSP215A	0.177	4.5	1000
CBMSP220A	0.197	5.0	1000

Item No.	A		Bulk Pack Qty.
	In	mm	
CBMSP230A	0.276	7.0	1000
CBMSP245A	0.413	10.5	1000
CBMSP255A	0.551	14.0	1000

BHC Blind Non-Locking Support

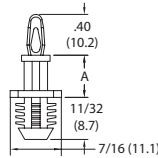

Snap Lock:
.156 (4.0)
Panel Thickness:
.062 (1.6)

Press Fit:
.312 (7.9)
Panel Thickness:
1/4 (6.4) Min.

Specifications:

- Material: Nylon 6/6
- Color: Natural
- Flame Class: UL94 V-2

Item No.	A		Bulk Pack Qty.
	In	mm	
BHC-3-01	0.188	4.8	1000
BHC-4-01	0.250	6.4	1000
BHC-6-01	0.375	9.5	1000
BHC-8-01	0.500	12.7	1000

Item No.	A		Bulk Pack Qty.
	In	mm	
BHC-10-01	0.625	15.9	1000
BHC-12-01	0.750	19.1	1000
BHC-14-01	0.875	22.2	1000



MSP Series Mini Support Post

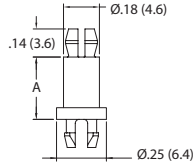
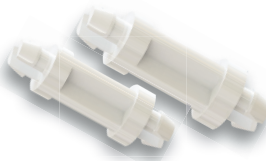

Snap-Fit:
.152 (3.9)
Panel Thickness:
.062 (1.6)

Snap-Lock:
.152 (3.9)
Panel Thickness:
.062 (1.6)

Item No.	A		Bulk Pack Qty.
	In	mm	
MSPE-2-01	0.125	3.2	1000
MSPE-3-01	0.188	4.8	1000
MSPE-4-01	0.250	6.4	1000
MSPE-5-01	0.313	7.9	1000
MSPE-6-01	0.375	9.5	1000
MSPE-7-01	0.438	11.1	1000

Item No.	A		Bulk Pack Qty.
	In	mm	
MSPE-8-01	0.500	12.7	1000
MSPE-10-01	0.625	15.9	1000
MSPE-11-01	0.688	17.5	1000
MSPE-12-01	0.750	19.1	1000
MSPE-14-01	0.875	22.2	1000

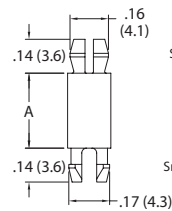
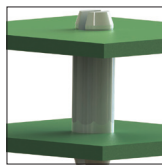

Top Hole:
Snap-fit: .152 (3.86)
Panel Thickness:
.062 (1.57)

Bottom Hole:
Snap-lock: .152 (3.86)
Panel Thickness:
.062 (1.57)

- Board mount head is releasable
- Chassis mount head locks permanently
- Material: UL94 V-2 Nylon 6/6
- Color: Natural



Item No.	Standoff Height	Bulk Pack Qty.
MSP-2-01	1/8 (3.2)	1000
MSP-3-01	3/16 (4.8)	1000
MSP-4-01	1/4 (6.4)	1000
MSP-5-01	5/16 (7.9)	1000
MSP-6-01	3/8 (9.5)	1000
MSP-7-01	7/16 (11.1)	1000
MSP-8-01	1/2 (12.7)	1000
MSP-9-01	9/16 (14.3)	1000
MSP-10-01	5/8 (15.9)	1000
MSP-11-01	11/16 (17.5)	1000
MSP-12-01	3/4 (19.1)	1000

Item No.	Standoff Height	Bulk Pack Qty.
MSP-13-01	13/16 (20.6)	1000
MSP-14-01	7/8 (22.2)	1000
MSP-16-01	1 (25.4)	1000
MSP-18-01	1-1/8 (28.6)	1000
MSP-20-01	1-1/4 (31.8)	1000
MSP-22-01	1-3/8 (34.9)	1000
MSP-24-01	1-1/2 (38.1)	1000
MSPE-16-01	1 (25.4)	1000
MSPE-20-01	1-1/4 (31.8)	1000
MSPE-22-01	1-3/8 (34.9)	1000

Specifications:

- Material: Nylon 6/6
- Color: Natural
- Flame Class: UL94 V-2

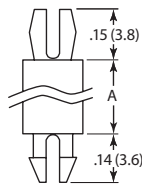

To Fit Hole:
.125 (3.2)
Panel Thickness:
.062 (1.6)

To Fit Hole:
.125 (3.2)
Panel Thickness:
.062 (1.6)

Item No.	A		Bulk Pack Qty.
	In	mm	
MSPM-2-01	0.125	3.2	1000
MSPM-3-01	0.187	4.8	1000
MSPM-4-01	0.250	6.4	1000
MSPM-5-01	0.312	7.9	1000
MSPM-6-01	0.375	9.5	1000
MSPM-7-01	0.437	11.1	1000
MSPM-8-01	0.500	12.7	1000
MSPM-9-01	0.562	14.3	1000
MSPM-10-01	0.625	15.9	1000
CBMSP050A	0.630	16.0	1000
CBMSP055A	0.687	17.5	1000

Item No.	A		Bulk Pack Qty.
	In	mm	
MSPM-12-01	0.750	19.1	1000
MSPM-13-01	0.811	20.6	1000
CBMSP070A	0.827	21.0	1000
MSPM-14-01	0.875	22.2	1000
MSPM-16-01	1.000	25.4	1000
MSPM-18-01	1.122	28.5	1000
MSPM-20-01	1.250	31.7	1000
CBMSP095A	1.252	31.8	1000
MSPM-24-01	1.375	34.9	1000
CBMSP105A	1.500	38.1	1000

CRLCBSR Reverse Locking Domed Support

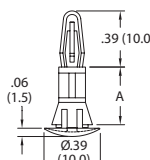

Snap Lock:
.157 (4.0)
Panel Thickness:
.063 (1.6)

Snap Lock:
.236 (6.0)
Panel Thickness:
.031-.047 (0.8-1.2)

Specifications:

- Material: Nylon 6/6
- Color: Natural
- Flame Class: UL94 V-2

Item No.	A		Bulk Pack Qty.
	In	mm	
CRLCBSR-3-01	0.188	4.8	1000
CRLCBSR-4-01	0.250	6.4	1000
CRLCBSR-5-01	0.313	7.9	1000

Item No.	A		Bulk Pack Qty.
	In	mm	
CRLCBSR-6-01	0.375	9.5	1000
CRLCBSR-8-01	0.500	12.7	1000
CRLCBSR-12-01	0.750	19.1	1000



REVERSE MOUNT CIRCUIT BOARD SUPPORTS



CRLCBSRE Reverse Locking Domed Support

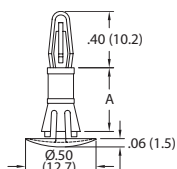

Snap Lock: .157 (4.0)
Panel Thickness: .063 (1.6)

Snap Lock: .213 (5.4)
Panel Thickness: .047-.079 (1.2-2.0)

Specifications:

- Material: Nylon 6/6
- Color: Natural
- Flame Class: UL94 V-2

Item No.	A		Bulk Pack Qty.
	In	mm	
CRLCBSRE-4-01	0.250	6.4	1000
CRLCBSRE-6-01	0.375	9.5	1000
CRLCBSRE-8-01	0.500	12.7	1000
CRLCBSRE-10-01	0.625	15.9	1000

CRLCBSK-2 Metric Cupped Reverse Locking Circuit Board Support

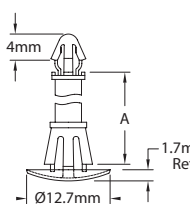
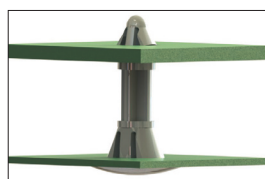

Top Hole: Snap-lock: 4mm
Panel Thickness: 1.6mm

Bottom Hole: Snap-lock: 5.4mm
Panel Thickness: 1mm - 1.6mm

- Cupped head provides tight holding in chassis
- Inserts into both holes from chassis underside
- Material: UL94 V-2 Nylon 6/6
- Color: Natural

Item No.	"A" Standoff Height mm	Bulk Pack Qty.
CRLCBSK-2-10-01	10	1000
CRLCBSK-2-12-01	12	1000
CRLCBSK-2-14-01	14	1000

CBRLDS Series Reverse Locking Domed Support



Specifications:

- Material: Nylon 6/6
- Color: Natural
- Flame Class: UL94 V-2

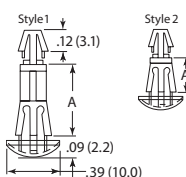

To Lock Hole: .157 (4.0)
Panel Thickness: .047-.066 (1.2-1.7)

To Lock Hole: .216 (5.5)
Panel Thickness: .031-.062 (0.8-1.6)

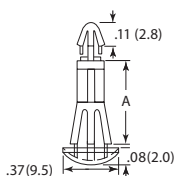

To Lock Hole: .137 (3.5)
Panel Thickness: .062 (1.6)

To Lock Hole: .216 (5.5)
Panel Thickness: .031-.062 (0.8-1.6)

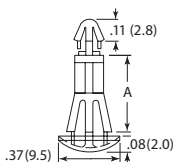

To Lock Hole: .118 (3.0)
Panel Thickness: .047-.066 (1.2-1.7)

To Lock Hole: .216 (5.5)
Panel Thickness: .023-.047 (0.1-1.2)

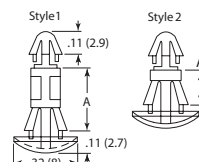

To Lock Hole: .118 (3.0)
Panel Thickness: .062 (1.6)

To Lock Hole: .157 (4.0)
Panel Thickness: .031-.062 (0.8-1.6)

Item No.	A			Bulk Pack Qty.
	In	mm	Style	
CBRLDS005A	0.138	3.5	2	1000
CBRLDS010A	0.197	5.0	2	1000
CBRLDS015A	0.250	6.4	2	1000
CBRLDS020A	0.276	7.0	1	1000
CBRLDS025A	0.315	8.0	1	1000
CBRLDS030A	0.335	8.5	1	1000
CBRLDS035A	0.394	10.0	1	1000
CBRLDS040A	0.472	12.0	1	1000
CBRLDS045A	0.500	12.7	1	1000
CBRLDS050A	0.531	13.5	1	1000

Item No.	A			Bulk Pack Qty.
	In	mm	Style	
CBRLDS055A	0.551	14.0	1	1000
CBRLDS060A	0.598	15.2	1	1000
CBRLDS065A	0.625	15.9	1	1000
CBRLDS070A	0.709	18.0	1	1000
CBRLDS075A	0.748	19.0	1	1000
CBRLDS080A	1.787	20.0	1	1000
CBRLDS085A	1.854	21.7	1	500
CBRLDS090A	1.945	24.0	1	500
CBRLDS095A	1.000	25.4	1	500
CBRLDS100A	1.181	30.0	1	500

Item No.	A		Bulk Pack Qty.
	In	mm	
CBRLDS205A	0.138	3.5	1000
CBRLDS210A	0.187	4.8	1000
CBRLDS215A	0.250	6.4	1000
CBRLDS220A	0.276	7.0	1000
CBRLDS225A	0.315	8.0	1000

Item No.	A		Bulk Pack Qty.
	In	mm	
CBRLDS230A	0.394	10.0	1000
CBRLDS235A	0.433	11.0	1000
CBRLDS240A	0.500	12.7	1000
CBRLDS245A	0.625	15.9	1000

Item No.	A			Bulk Pack Qty.
	In	mm	Style	
CBRLDS305A	0.138	3.5	1000	
CBRLDS310A	0.188	4.8	1000	
CBRLDS315A	0.250	6.4	1000	
CBRLDS320A	0.276	7.0	1000	
CBRLDS325A	0.315	8.0	1000	

Item No.	A			Bulk Pack Qty.
	In	mm	Style	
CBRLDS330A	0.394	10.0	1000	
CBRLDS335A	0.433	11.0	1000	
CBRLDS340A	0.500	12.7	1000	
CBRLDS345A	0.625	15.9	1000	

Item No.	A			Bulk Pack Qty.
	In	mm	Style	
CBRLDS405A	0.098	2.5	2	2000
CBRLDS410A	0.125	3.2	2	2000
CBRLDS415A	0.157	4.0	2	2000
CBRLDS420A	0.197	5.0	1	2000
CBRLDS425A	0.236	6.0	1	2000
CBRLDS430A	0.276	7.0	1	1000

Item No.	A			Bulk Pack Qty.
	In	mm	Style	
CBRLDS435A	0.315	8.0	1	1000
CBRLDS440A	0.354	9.0	1	1000
CBRLDS445A	0.394	10.0	1	1000
CBRLDS450A	0.472	12.0	1	1000
CBRLDS455A	0.551	14.0	1	1000
CBRLDS460A	0.630	16.0	1	1000



Request Info

1-800-453-1692



www.aboveboardelectronics.com

REVERSE MOUNT LOCKING CIRCUIT BOARD SUPPORTS

Buy One or Buy Bulk & SAVE

RLCBS Series Reverse Mounted Locking Support

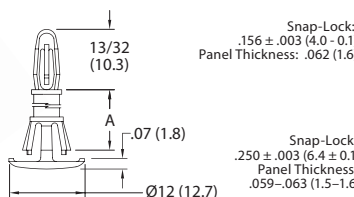
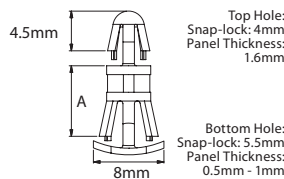
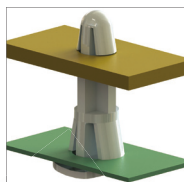
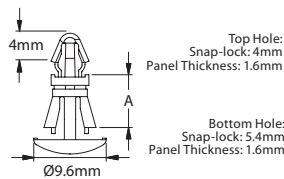
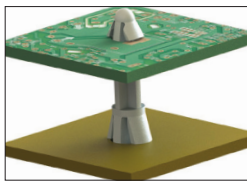
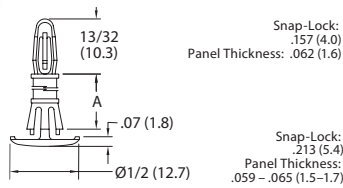
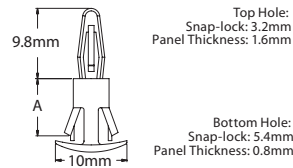
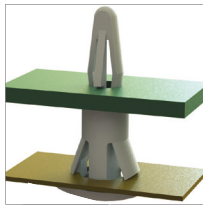
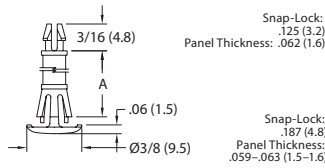
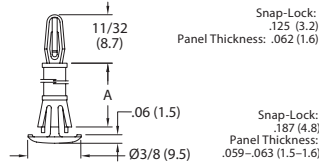

Specifications:

- Material: Nylon 6/6
- Color: Natural
- Flame Class: UL94 V-2



Item No.	A		Bulk Pack Qty.
	In	mm	
RLCBSR-4-01	0.250	6.4	1000
RLCBSR-5-01	0.313	7.9	1000
RLCBSR-6-01	0.375	9.5	1000
RLCBSR-7-01	0.438	11.1	1000

Item No.	A		Bulk Pack Qty.
	In	mm	
RLCBSR-8-01	0.500	12.7	1000
RLCBSR-9-01	0.563	14.3	1000
RLCBSR-10-01	0.625	15.9	1000



Item No.	A		Bulk Pack Qty.
	In	mm	
RLCBSR-4-01	0.250	6.4	1000
RLCBSR-5-01	0.313	7.9	1000
RLCBSR-6-01	0.375	9.5	1000
RLCBSR-7-01	0.438	11.1	1000

Item No.	A		Bulk Pack Qty.
	In	mm	
RLCBSR-8-01	0.500	12.7	1000
RLCBSR-9-01	0.563	14.3	1000
RLCBSR-10-01	0.625	15.9	1000



Item No.	"A" Standoff Height		Bulk Pack Qty.
	In	mm	
RLCBSC-5-01	5	1000	
RLCBSC-6-01	6	1000	
RLCBSC-8-01	8	1000	
RLCBSC-10-01	10	1000	
RLCBSC-12-01	12	1000	
RLCBSC-14-01	14	1000	



Item No.	A		Bulk Pack Qty.
	In	mm	
RLCBSRE-4-01	0.250	6.4	1000
RLCBSRE-6-01	0.375	9.5	1000
RLCBSRE-8-01	0.500	12.7	1000
RLCBSRE-10-01	0.625	15.9	1000



Item No.	"A" Standoff Height		Bulk Pack Qty.
	In	mm	
RLCBSK-6-01	6	1000	
RLCBSK-7-01	7	1000	
RLCBSK-8-01	8	1000	
RLCBSK-10-01	10	1000	
RLCBSK-12-01	12	1000	
RLCBSK-14-01	14	1000	
RLCBSK-16-01	16	1000	



Item No.	"A" Standoff Height		Bulk Pack Qty.
	In	mm	
RLCBSA-5-01	5	1000	
RLCBSA-6-01	6	1000	
RLCBSA-8-01	8	1000	
RLCBSA-10-01	10	1000	
RLCBSA-12-01	12	1000	
RLCBSA-14-01	14	1000	



Item No.	A		Bulk Pack Qty.
	In	mm	
RLCBSR1-4-01	0.250	6.4	1000
RLCBSR1-6-01	0.375	9.5	1000
RLCBSR1-8-01	0.500	12.7	1000
RLCBSR1-10-01	0.625	15.9	1000

REVERSE MOUNT, NON-LOCKING & EDGE LOCKING CIRCUIT BOARD SUPPORTS



RCBSR Reverse Mounted Non-Locking Support

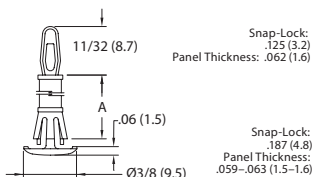

Item No.	A		Bulk Pack Qty.
	In	mm	
RCBSR-4-01	0.250	6.4	1000
RCBSR-5-01	0.313	7.9	1000
RCBSR-6-01	0.375	9.5	1000
RCBSR-7-01	0.438	11.1	1000

Item No.	A		Bulk Pack Qty.
	In	mm	
RCBSR-8-01	0.500	12.7	1000
RCBSR-9-01	0.563	14.3	1000
RCBSR-10-01	0.625	15.9	1000

CRCBSRE Reverse Mount Non-Locking Support

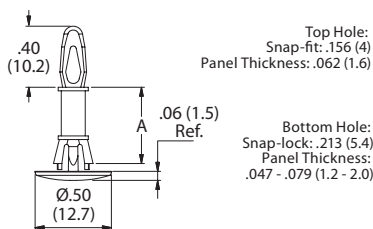
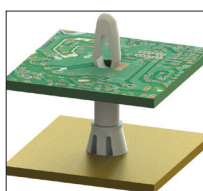

- Inserts into both holes from chassis underside
- Thin buttonhead for minimal protrusion under chassis
- Cupped head provides for tight holding in chassis
- Material: UL94 V-2 Nylon 6/6
- Color: Natural

Item No.	"A" Standoff Height	Bulk Pack Qty.
CRCBSRE-3-01	3/16 (4.8)	1000
CRCBSRE-4-01	1/4 (6.4)	1000
CRCBSRE-6-01	3/8 (9.5)	1000
CRCBSRE-8-01	1/2 (12.7)	1000
CRCBSRE-10-01	5/8 (15.9)	1000

EHCBS Edge Holding Circuit Board Support

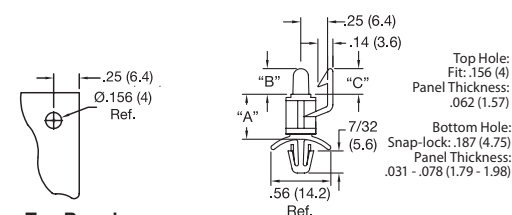
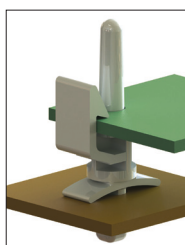

Top Board Hole Location

Item No.			"A" Standoff Height	Bulk Pack Qty.
"B" = .60 (15.2)	"B" = .24 (6.1)	"B" = .24 (6.1)	5/16 (7.9)	1000
"C" = .29 (7.5)	"C" = .24 (6.1)	"C" = .29 (7.5)		
EHCBS-5-01	EHCBS-6-5-01	EHCBS-7-5-01	3/8 (9.5)	1000
EHCBS-6-01	EHCBS-6-6-01	EHCBS-7-6-01	1/2 (12.7)	1000
EHCBS-8-01	EHCBS-6-8-01	EHCBS-7-8-01	5/8 (15.9)	1000
EHCBS-10-01	EHCBS-6-10-01	EHCBS-7-10-01	7/8 (22.2)	1000
EHCBS-12-01	EHCBS-6-12-01	EHCBS-7-12-01	1 (25.4)	1000
EHCBS-14-01	EHCBS-6-14-01	EHCBS-7-14-01		
EHCBS-16-01	EHCBS-6-16-01	EHCBS-7-16-01		

- Long nose facilitates alignment of components on board with the mating parts on the chassis
- PCB is easy to remove for service
- Material: UL94 V-2 Nylon 6/6
- Color: Natural

Item No.	A	Bulk Pack Qty.
CBEHS005A	0.250 6.4	1000

TEHCBS Series Edge Holding Support

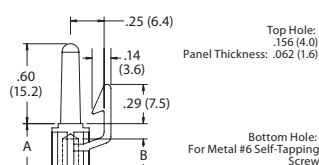

- Specifications:
- Material: Nylon 6/6
 - Color: Natural
 - Flame Class: UL94 V-2

Item No.	A		B		Bulk Pack Qty.
	In	mm	In	mm	
TEHCBS-4-01	0.250	6.4	0.250	6.4	1000
TEHCBS-5-01	0.313	7.9	0.200	5.1	1000
TEHCBS-6-01	0.375	9.5	0.250	6.4	1000
TEHCBS-8-01	0.500	12.7	0.250	6.4	1000
TEHCBS-10-01	0.625	15.9	0.250	6.4	1000
TEHCBS-12-01	0.750	19.1	0.250	6.4	1000
TEHCBS-14-01	0.875	22.2	0.250	6.4	1000
TEHCBS-16-01	1.000	25.4	0.250	6.4	1000

EDGE LOCKING CIRCUIT BOARD SUPPORTS

Buy One or Buy Bulk & SAVE

TEHCBS Series Edge Holding Support

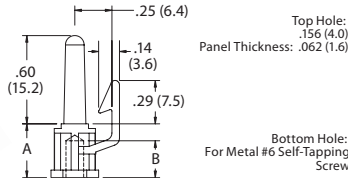

- Specifications:
- Material: Nylon 6/6
 - Color: Natural
 - Flame Class: UL94 V-2



Item No.	A		B		Bulk Pack Qty.
	In	mm	In	mm	
TEHCBS-4-01	0.250	6.4	0.250	6.4	1000
TEHCBS-5-01	0.313	7.9	0.200	5.1	1000
TEHCBS-6-01	0.375	9.5	0.250	6.4	1000
TEHCBS-8-01	0.500	12.7	0.250	6.4	1000

Item No.	A		B		Bulk Pack Qty.
	In	mm	In	mm	
TEHCBS-10-01	0.625	15.9	0.250	6.4	1000
TEHCBS-12-01	0.750	19.1	0.250	6.4	1000
TEHCBS-14-01	0.875	22.2	0.250	6.4	1000
TEHCBS-16-01	1.000	25.4	0.250	6.4	1000

RLEHCBS Reverse Locking Edge Holding Circuit Board Support

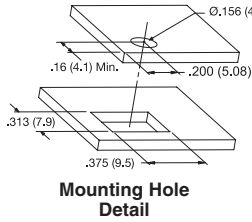
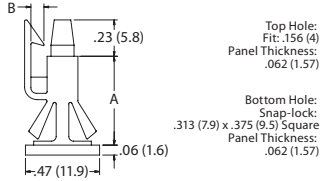
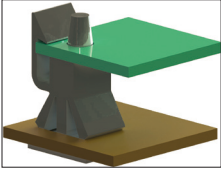

- Use in a square hole to prevent rotation
- Locking arm secures the board
- Board is removable for repair or service
- Material: UL94 V-2 Nylon 6/6
- Color: Black



Item No.	"A" Standoff Height		Bulk Pack Qty.
	In	mm	
RLEHCBS-5-01BK	.38 (9.5)	.06 (1.5)	1000
RLEHCBS-6-01BK	.44 (11.1)	.06 (1.5)	1000
RLEHCBS-7-01BK	.50 (12.7)	.08 (2.1)	1000
RLEHCBS-8-01BK	.56 (14.3)	.08 (2.1)	1000

PCBEH PCB Edge Holder

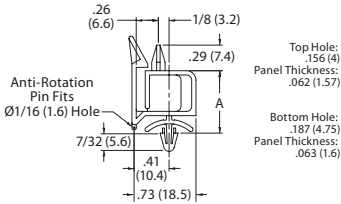
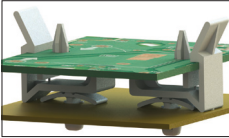

- Pin prevents rotation
- PCB is easy to remove for service
- Material: UL94 V-2 Nylon 6/6
- Color: Natural



Item No.	"A" Standoff Height		Bulk Pack Qty.
	In	mm	
PCBEH-7-01	.47 (11.9)		1000
PCBEH-10-01	.66 (16.8)		1000
PCBEH-14-01	.91 (23.1)		1000

UBM/UBMC Universal Board Mount/Universal Board Mount Clip

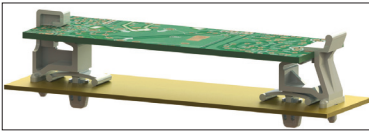

- Wide base minimizes rocking
- Releasable board lock
- Anti-Rotation pins
- Material: UL94 V-2 Nylon 6/6
- Color: Natural

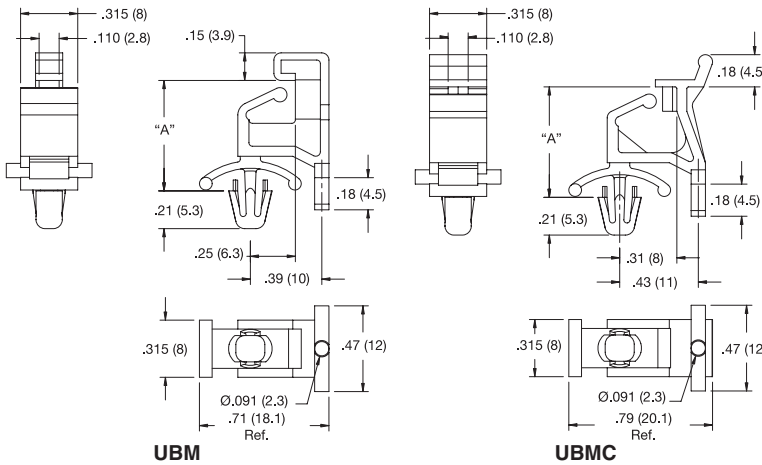

Top Hole: See Below
Panel Thickness: .06 - .09 (1.6 - 2.3)

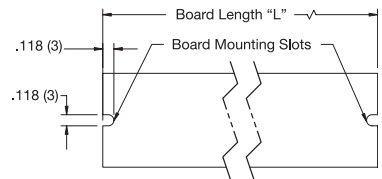

Bottom Hole: See Below
Panel Thickness: .04 - .09 (1 - 2.3)

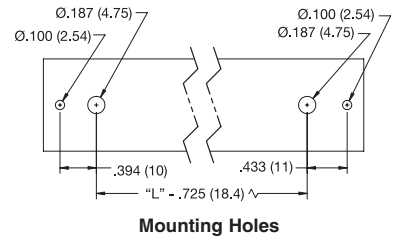

Item No.	Item No.	"A" Standoff Height		Bulk Pack Qty.
		In	mm	
UBMC-12.3M-01	UBMC-12.3M-01	.48 (12.3)		500
UBMC-15.5M-01	UBMC-15.5M-01	.61 (15.5)		500
UBMC-22.0M-01	UBMC-22.0M-01	.87 (22)		500

REHCBS Series Rivet Edge Holding Support

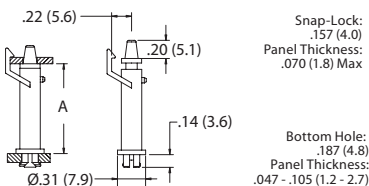

- Specifications:
- Material: Nylon 6/6
 - Color: Natural
 - Flame Class: UL94 V-2



Item No.	A		Bulk Pack Qty.
	In	mm	
REHCBS-4-01	0.250	6.4	1000
REHCBS-8-01	0.500	12.7	1000

SCREW MOUNT CIRCUIT BOARD SUPPORTS



TCBS Self-Tapping & Threaded Support

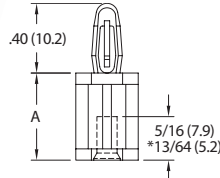

Snap-Lock: .156 (4.0)
Panel Thickness: .062 (1.6)

Specifications:

- Material: Nylon 6/6
- Color: Natural

#6 Self Tapping Screw

Item No.	UL94 V-2	UL94 V-0	A		Bulk Pack Qty.
	In	mm	In	mm	
TCBS-4-01*	TCBS-4-19*	0.250	6.4	1000	
TCBS-6-01	TCBS-6-19	0.375	9.5	1000	
TCBS-8-01	TCBS-8-19	0.500	12.7	1000	
TCBS-10-01	TCBS-10-19	0.625	15.9	1000	
TCBS-12-01	TCBS-12-19	0.750	19.1	1000	

Item No.	UL94 V-2	UL94 V-0	A		Bulk Pack Qty.
	In	mm	In	mm	
TCBS-14-01	TCBS-14-19	0.875	22.2	1000	
TCBS-16-01	TCBS-16-19	1.000	25.4	1000	
TCBS-18-01	TCBS-18-19	1.125	28.6	1000	
TCBS-20-01	TCBS-20-19	1.250	31.8	1000	
TCBS-22.5-01	TCBS-22.5-19	1.416	35.7	1000	



TCBN Metric Female Threaded Circuit Board Support

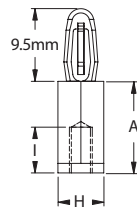
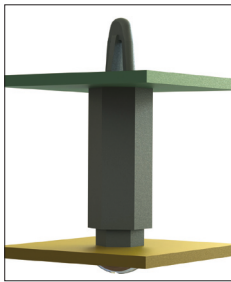

Top Hole: Snap-lock: 4mm
Panel Thickness: 1.6mm

Bottom Hole: See Table for Female Thread Size

- Material: UL94 HB, Nylon 6/6
- Color: Black

#M3 or M4 Screw

Item No.	Thread	"H" mm	"A" Standoff Height mm	"I" mm	Bulk Pack Qty.
TCBN-T1-M3-6-5	M3	6	5	3	500
TCBN-T1-M3-6-6	M3	6	6	4	500
TCBN-T1-M3-6-8	M3	6	8	6	500
TCBN-T1-M4-8-5	M4	8	5	3	500
TCBN-T1-M4-8-6	M4	8	6	4	500
TCBN-T1-M4-8-8	M4	8	8	6	500

LCBS-TF Locking Support, Threaded Female

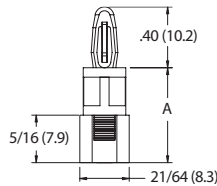

Snap-Lock: .156 (4.0)
Panel Thickness: .062 (1.6)

Specifications:

- Material: Nylon 6/6
- Color: Natural
- Flame Class: UL94 V-2

#6 - 32 Screw

Item No.	A		Bulk Pack Qty.
	In	mm	
LCBS-TF-6-01	0.375	9.5	1000
LCBS-TF-8-01	0.500	12.7	1000
LCBS-TF-10-01	0.625	15.9	1000
LCBS-TF-12-01	0.750	19.1	1000
LCBS-TF-14-01	0.875	22.2	1000
LCBS-TF-16-01	1.000	25.4	1000



LCCBS-TF Locking Circuit Board Support, Threaded Female

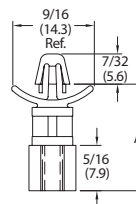
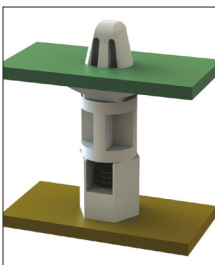

Top Hole: Snap-lock: .187 (4.75)
Panel Thickness: .062 (1.57)

Bottom Hole: #6-32 Female Thread

- PC board is locked securely in place
- Internal thread to be mounted with a #6-32 screw
- Material: Nylon 6/6
- Color: Natural

#6 - 32 Screw

Item No.	UL94 V-2	UL94 V-0	"A" Standoff Height mm	Bulk Pack Qty.
LCCBS-TF-9-01	LCCBS-TF-9-19		.534 (13.56)	1000
LCCBS-TF-10-01	LCCBS-TF-10-19		.672 (17.07)	1000
LCCBS-TF-12-01	LCCBS-TF-12-19		.797 (20.24)	1000
LCCBS-TF-14-01	LCCBS-TF-14-19		.922 (23.42)	1000
LCCBS-TF-16-01	LCCBS-TF-16-19		1.047 (25.40)	1000



CBS-TF Circuit Board Support, Threaded Female

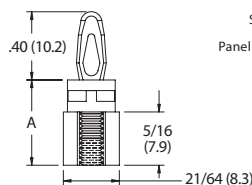
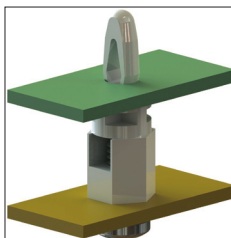

Snap-Lock: .156 (4.0)
Panel Thickness: .062 (1.6)

Specifications:

- Material: Nylon 6/6
- Color: Natural

#6 - 32 Screw

Item No.	UL94 V-2	UL94 V-0	A		Bulk Pack Qty.
	In	mm	In	mm	
CBS-TF-6-01	CBS-TF-6-19	0.375	9.5	1000	
CBS-TF-8-01	CBS-TF-8-19	0.500	12.7	1000	
CBS-TF-10-01	CBS-TF-10-19	0.625	15.9	1000	
CBS-TF-12-01	CBS-TF-12-19	0.750	19.1	1000	
CBS-TF-14-01	CBS-TF-14-19	0.875	22.2	1000	
CBS-TF-16-01	CBS-TF-16-19	1.000	25.4	1000	



SCREW & RIVET MOUNT CIRCUIT BOARD SUPPORTS

Buy One or Buy Bulk & SAVE

SFCBS Series Stud Fitting Support

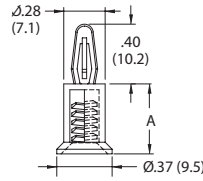
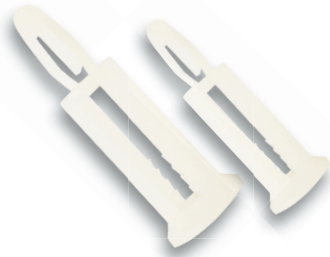

Snap-Lock: .156 (4.0)
Panel Thickness: .062 (1.6)

Bottom Hole: To fit a #8 (M4) screw or stud

#8 (M4)

Specifications:

- Material: Nylon 6/6
- Color: Natural
- Flame Class: UL94 V-2

Item No.	"A"		Bulk Pack Qty.
	In	mm	
SFCBS-M4-10M-01	0.390	9.9	1000
SFCBS-M4-12M-01	0.470	11.9	1000
SFCBS-M4-14M-01	0.550	14.0	1000
SFCBS-M4-16M-01	0.630	16.0	1000
SFCBS-M4-18M-01	0.710	18.0	1000
SFCBS-M4-20M-01	0.790	20.1	1000

LCBS-L Screw Mount Locking Circuit Board Support

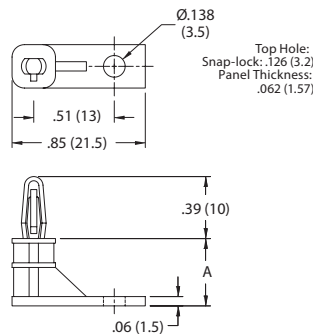
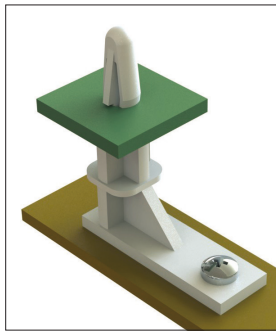

- Installs with #4 (M3) screw or rivet
- Offset style allows dense packaging
- Material: UL94 V-2 Nylon 6/6
- Color: Natural

Item No.	"A" Standoff Height	Bulk Pack Qty.
LCBS-L-5-01	5/16 (7.6)	1000
LCBS-L-6-01	3/8 (9.5)	1000
LCBS-L-7-01	7/16 (11.1)	1000
LCBS-L-8-01	1/2 (12.7)	1000
LCBS-L-9-01	9/16 (14.3)	1000
LCBS-L-10-01	5/8 (15.9)	1000

CBSS Circuit Board Stacking Spacer

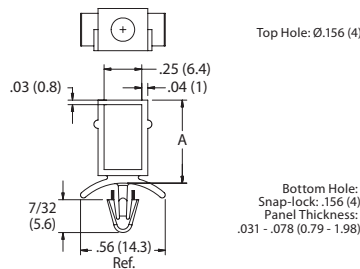
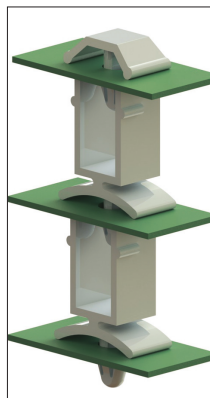

- Spacers snap together to stack any number of boards
- MB-1-156 mounting button caps off the stack. See page 739
- Barbed arrow mount locks securely
- Material: Nylon 6/6
- Color: Natural

Item No.	Material: UL94 V-2	Material: UL94 V-0	"A" Standoff Height	Bulk Pack Qty.
CBSS-8-01		CBSS-8-19	.43 (10.9)	1000
CBSS-10-01		CBSS-10-19	.55 (14)	1000
CBSS-12-01		CBSS-12-19	.68 (17.3)	1000
CBSS-14-01		CBSS-14-19	.80 (20.3)	1000

RIVET & SLOT MOUNT CIRCUIT BOARD SUPPORTS



SRL Series Snap Rivet Locking Support

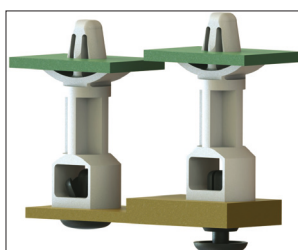
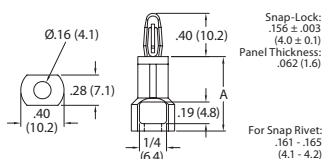
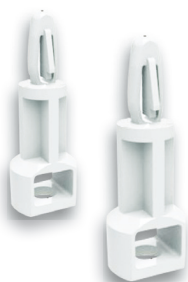

- Designed to mount easily on chassis with plastic SR rivet, see Rivet Table
- Allows mounting to a range of panel thicknesses, up to .341" thick
- Button head on rivet for minimal protrusion on chassis underside

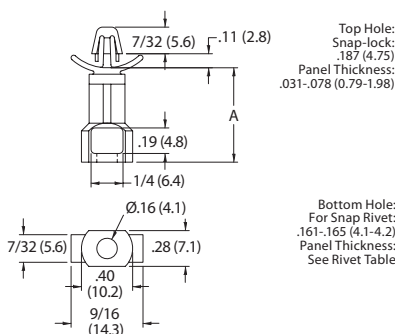

Specifications:

- Material: Nylon 6/6
- Color: Natural
- Flame Class: UL94 V-2



Item No.	A		Bulk Pack Qty.
	In	mm	
SRLCBS-6-01	0.375	9.5	1000
SRLCBS-7-01	0.438	11.1	1000
SRLCBS-8-01	0.500	12.7	1000
SRLCBS-10-01	0.625	15.9	1000
SRLCBS-12-01	0.750	19.1	1000
SRLCBS-14-01	0.875	22.2	1000
SRLCBS-16-01	1.000	25.4	1000

Use With Rivet	Panel Thickness Range	
	In	mm
SR-4050	0.026 - 0.062	0.66 - 1.57
SR-4060	0.062 - 0.105	1.57 - 2.67
SR-4070	0.105 - 0.145	2.67 - 3.68
SR-4080	0.145 - 0.184	3.68 - 4.67
SR-4090	0.184 - 0.223	4.67 - 5.66
SR-4100	0.223 - 0.263	5.66 - 6.68
SR-4120	0.282 - 0.341	7.16 - 8.66



Item No.	"A" Standoff Height	Bulk Pack Qty.
SRLAHS-7-01	7/16 (11.1)	1000
SRLAHS-8-01	1/2 (12.7)	1000
SRLAHS-10-01	5/8 (15.9)	1000
SRLAHS-12-01	3/4 (19.1)	1000
SRLAHS-14-01	7/8 (22.2)	1000
SRLAHS-16-01	1 (25.4)	1000

SMLCBS Side Mount Locking Circuit Board Support

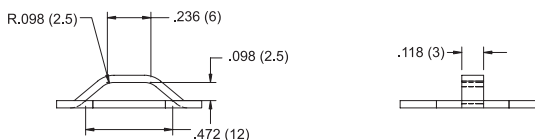
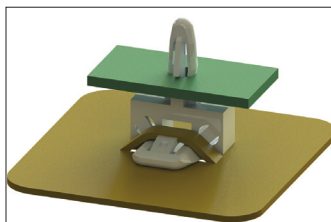

Recommended Mounting Slot

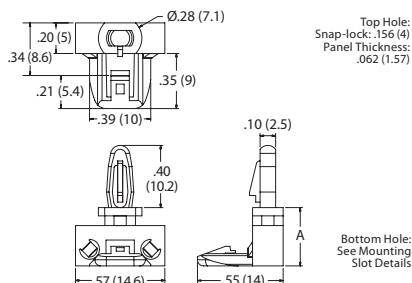

- Slides easily into pre-formed slot, leaving no protrusion under the chassis
- Removable by pressing the locking tab
- Material: Nylon 6/6
- Color: Natural

Item No.	"A" Standoff Height	Bulk Pack Qty.	
UL94 V-2	UL94 V-0		
SMLCBS-5-01	SMLCBS-5-19	5/16 (7.9)	1000
SMLCBS-6-01	SMLCBS-6-19	3/8 (9.5)	1000
SMLCBS-7-01	SMLCBS-7-19	7/16 (11.1)	1000
SMLCBS-8-01	SMLCBS-8-19	1/2 (12.7)	1000



Request Info

1-800-453-1692

www.aboveboardelectronics.com

SLOT MOUNT CIRCUIT BOARD SUPPORTS & CIRCUIT BOARD SUPPORTS ON BASE

Buy One or Buy Bulk & SAVE

KSLBN Key Slot with Locking Bayonet Nose

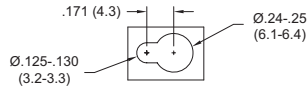
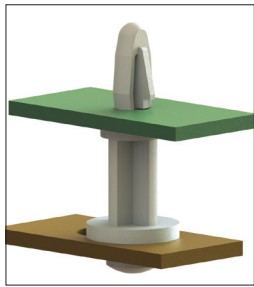

Recommended Mounting Slot

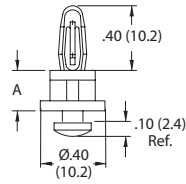

- Key Slot design allows for easy removal to facilitate repairs
- Minimal .10" protrusion under chassis
- Larger base on key slot side for easy identification of mounting end
- Material: UL94 V-2 Nylon 6/6
- Color: Natural

Item No.	"A"	Bulk Pack Qty.
KSLBN-2-01	1/8 (3.2)	1000
KSLBN-4-01	1/4 (6.4)	1000
KSLBN-6-01	3/8 (9.5)	1000
KSLBN-8-01	1/2 (12.7)	1000



KSLSP Key Slot Locking Support Post

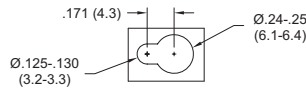
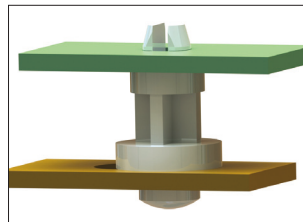

Recommended Mounting Slot

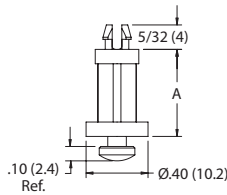

- Key Slot design allows for easy removal to facilitate repairs
- Minimal .10" protrusion under chassis
- Larger base on key slot side for easy identification of mounting end
- Material: UL94 V-2 Nylon 6/6
- Color: Natural

Item No.	Item No.	"A" Standoff Height	Bulk Pack Qty.
KSLSP1-3-01	KSLSP2-3-01	3/16 (4.8)	1000
KSLSP1-4-01	KSLSP2-4-01	1/4 (6.4)	1000
KSLSP1-6-01	KSLSP2-6-01	3/8 (9.5)	1000
KSLSP1-8-01	KSLSP2-8-01	1/2 (12.7)	1000
KSLSP1-10-01	KSLSP2-10-01	5/8 (15.9)	1000



LCBSB/CBSB/CBABS Series Adhesive Base Support

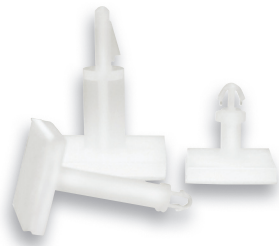

- Adhesive base eliminates the need for mounting hole on the chassis

Specifications:

- Material: Nylon 6/6
- Color: Natural
- Flame Class: UL94 V-2

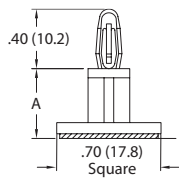

Snap Lock: .156 (4.0) Panel Thickness: .062 (1.6)

Item No.	A		Bulk Pack Qty.
	In	mm	
LCBSB-3-01A-RT	0.188	4.8	1000
LCBSB-4-01A-RT	0.250	6.4	1000
CBABS015A	0.315	8.0	500
LCBSB-6-01A-RT	0.386	9.8	1000
LCBSB-8-01A-RT	0.504	12.8	1000
LCBSB-9-01A-RT	0.563	14.3	1000
LCBSB-10-01A-RT	0.625	15.9	500
LCBSB-12-01A-RT	0.750	19.1	1000
LCBSB-14-01A-RT	0.875	22.2	1000
LCBSB-16-01A-RT	1.000	25.4	1000
LCBSB-18-01A-RT	1.125	28.6	1000

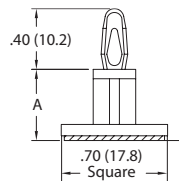

Snap Fit: .156 (4.0) Panel Thickness: .062 (1.6)

Item No.	A		Bulk Pack Qty.
	In	mm	
CBSB-3-01A-RT	0.188	4.8	1000
CBSB-4-01A-RT	0.250	6.4	1000
CBSB-6-01A-RT	0.375	9.5	1000
CBSB-8-01A-RT	0.500	12.7	1000
CBSB-9-01A-RT	0.563	14.3	1000
CBSB-10-01A-RT	0.625	15.9	1000
CBSB-12-01A-RT	0.750	19.1	1000
CBSB-14-01A-RT	0.875	22.2	1000
CBSB-16-01A-RT	1.000	25.4	1000
CBSB-18-01A-RT	1.125	28.6	1000

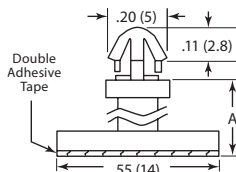

To Lock Hole: .137 (3.5) Panel Thickness: .047-.062 (1.2 - 1.6)

Item No.	A		Bulk Pack Qty.
	In	mm	
CBABS105A	0.138	3.5	1000
CBABS110A	0.187	4.8	1000
CBABS115A	0.250	6.4	1000
CBABS125A	0.315	8.0	1000
CBABS125A	0.394	10.0	1000

CIRCUIT BOARD SUPPORTS ON BASE



LCBSB/CBABS/CBSBT Series Adhesive Base Support

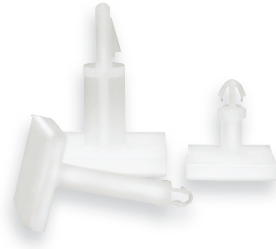

Specifications:

- Material: Nylon 6/6
- Color: Natural
- Flame Class: UL94 V-2

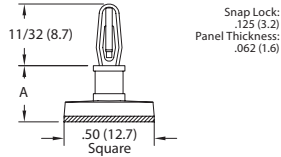

Item No.	A		Bulk Pack Qty.
	In	mm	
LCBSBM-3-01A-RT	0.188	4.8	1000
LCBSBM-4-01A-RT	0.250	6.4	1000
LCBSBM-5-01A-RT	0.313	7.9	1000
LCBSBM-6-01A-RT	0.375	9.5	1000
LCBSBM-7-01A-RT	0.438	11.1	1000
LCBSBM-8-01A-RT	0.500	14.3	1000
LCBSBM-9-01A-RT	0.563	14.3	1000
LCBSBM-10-01A-RT	0.625	15.9	1000

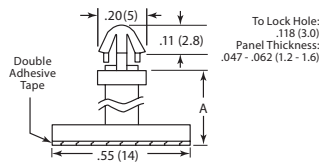

Item No.	A		Bulk Pack Qty.
	In	mm	
CBABS205A	0.138	3.5	1000
CBABS210A	0.187	4.8	1000
CBABS215A	0.250	6.4	1000
CBABS220A	0.315	8.0	1000
CBABS225A	0.394	10.0	1000

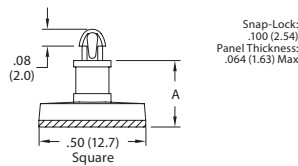

Item No.	A		Bulk Pack Qty.
	In	mm	
CBSBT-3-01A-RT	0.188	4.8	1000
CBSBT-4-01A-RT	0.250	6.4	1000
CBSBT-6-01A-RT	0.375	9.5	1000
CBSBT-7-01A-RT	0.438	11.1	1000
CBSBT-8-01A-RT	0.500	12.7	1000
CBSBT-9-01A-RT	0.563	14.3	1000
CBSBT-10-01A-RT	0.625	15.9	1000
CBABS335A	0.750	19.1	1000

CCBSBT Adhesive Mount Cupped Circuit Board Support

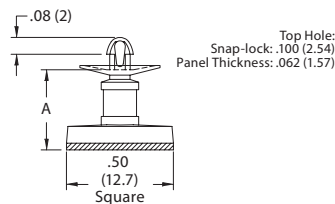
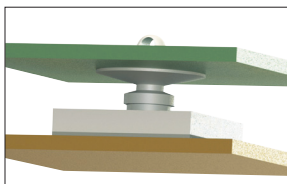

- Cupped base provides a tight fit to the board and completely covers the hole
- Teardrop mounting end has very small protrusion above the PC board
- Adhesive: 1/32 (0.8) thick tape
- Material: UL94 V-2 Nylon 6/6
- Color: Natural

Item No.	"A"		Bulk Pack Qty.
	Standoff Height		
CCBSBT-4-01A-RT	1/4 (6.4)	1000	
CCBSBT-5-01A-RT	5/16 (7.9)	1000	
CCBSBT-6-01A-RT	3/8 (9.5)	1000	
CCBSBT-7-01A-RT	7/16 (11.1)	1000	
CCBSBT-8-01A-RT	1/2 (12.7)	1000	
CCBSBT-9-01A-RT	9/16 (14.3)	1000	
CCBSBT-10-01A	5/8 (15.9)	1000	

CBABS Adhesive Base Support

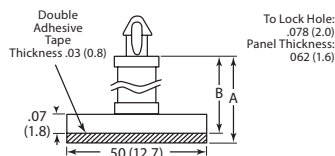

Specifications:

- Material: Nylon 6/6
- Color: Natural
- Flame Class: UL94 V-2

Item No.	A		B		Bulk Pack Qty.
	In	mm	In	mm	
CBABS405A	0.187	4.8	0.157	4.0	1000
CBABS410A	0.250	6.4	0.220	5.6	1000
CBABS415A	0.375	9.5	0.343	8.7	1000
CBABS420A	0.437	11.1	0.406	10.3	1000
CBABS425A	0.500	12.7	0.469	11.9	1000
CBABS430A	0.625	15.9	0.594	15.1	1000
CBABS435A	0.750	19.1	0.720	18.3	1000



1-800-453-1692

www.aboveboardelectronics.com

CIRCUIT BOARD SUPPORTS ON BASE & SELF THREADING CIRCUIT BOARD SUPPORTS

SCBSB Adhesive Mount Male Stud Circuit Board Support

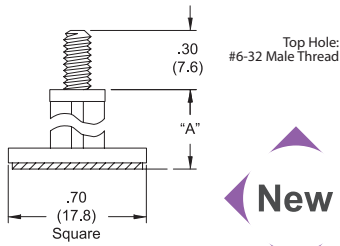
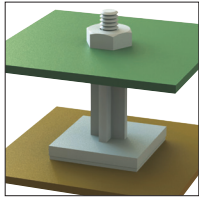

- #6-32 male thread is secured using Richco nylon hex nut item number HN-6-32-01. See page 813
- Adhesive: 1/32 (0.8) thick tape
- Material: UL94 V-2, Nylon 6/6
- Color: Natural

Item No.	"A" Standoff Height	Bulk Pack Qty.
SCBSB-4-01A-RT	1/4 (6.4)	1000
SCBSB-6-01A-RT	3/8 (9.5)	1000
SCBSB-8-01A-RT	1/2 (12.7)	1000
SCBSB-10-01A-RT	5/8 (15.9)	1000
SCBSB-12-01A-RT	3/4 (19.1)	1000
SCBSB-14-01A-RT	7/8 (22.2)	1000
SCBSB-16-01A-RT	1 (25.4)	1000
SCBSB-18-01A-RT	1 1/8 (28.6)	1000

PSB Push Spacer on Adhesive Base

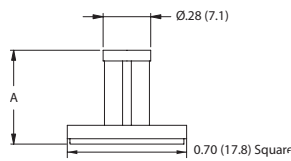
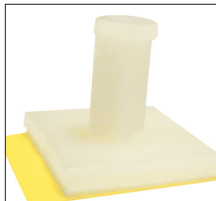

Specifications:

- Material: Nylon 6/6
- Color: Natural
- Adhesive backing: Double-sided adhesive tape with release tab

Item No.		A		Bulk Pack Qty.
UL94 V-2	UL94 V-0	In	mm	
PSB-6M-01A2-RT	PSB-6M-19A2-RT	0.236	6.0	1000
PSB-8 M-01A2-RT	PSB-8 M-19A2-RT	0.314	8.0	1000
PSB-10M-01A2-RT	PSB-10M-19A2-RT	0.393	10.0	1000
PSB-12M-01A2-RT	PSB-12M-19A2-RT	0.472	12.0	1000
PSB-14M-01A2-RT	PSB-14M-19A2-RT	0.551	14.0	1000
PSB-16M-01A2-RT	PSB-16M-19A2-RT	0.629	16.0	1000

PSBM Adhesive Mount Push Spacer

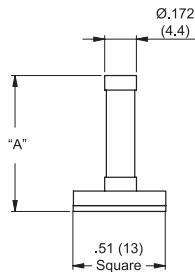

- Smaller size takes up less real estate on the board
- Adhesive: 1/32 (0.8) thick tape
- Material: Nylon 6/6
- Color: Natural

Item No.		"A" Standoff Height		Bulk Pack Qty.
UL94 V-2	UL94 V-0	In	mm	
PSBM-3-01A-RT	PSBM-3-19A-RT	.189	(4.8)	1000
PSBM-4-01A-RT	PSBM-4-19A-RT	.252	(6.4)	1000
PSBM-5-01A-RT	PSBM-5-19A-RT	.311	(7.9)	1000
PSBM-6-01A-RT	PSBM-6-19A-RT	.374	(9.5)	1000
PSBM-7-01A-RT	PSBM-7-19A-RT	.437	(11.1)	1000
PSBM-8-01A-RT	PSBM-8-19A-RT	.500	(12.7)	1000
PSBM-9-01A-RT	PSBM-9-19A-RT	.563	(14.3)	1000
PSBM-10-01A-RT	PSBM-10-19A-RT	.626	(15.9)	1000
PSBM-12-01A-RT	PSBM-12-19A-RT	.752	(19.1)	1000
PSBM-14-01A-RT	PSBM-14-19A-RT	.874	(22.2)	1000

SCBSST Circuit Board Support, Self-Threading

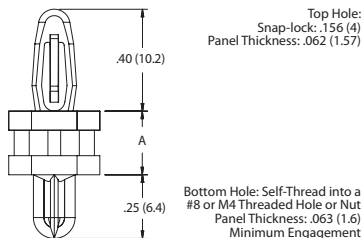
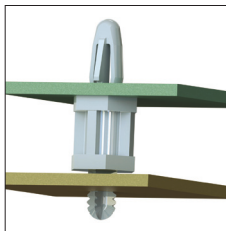

- The threaded hole acts as a die and threads the bottom end when screwed in
- Can be used in either a #8 or M4 threaded hole or Nut
- Easily installed by hand with minimal force
- Material: UL94 V-2 Nylon 6/6
- Color: Natural

Item No.	"A" Standoff Height	Bulk Pack Qty.
SCBSST-4-01	1/4 (6.4)	1000
SCBSST-6-01	3/8 (9.5)	1000
SCBSST-8-01	1/2 (12.7)	1000
SCBSST-10-01	5/8 (15.9)	1000
SCBSST-12-01	3/4 (19.1)	1000
SCBSST-14-01	7/8 (22.2)	1000
SCBSST-16-01	1 (25.4)	1000
SCBSST-18-01	1-1/8 (28.6)	1000
SCBSST-22.5-01	1-13/32 (35.7)	1000

MSPMST Micro Self-Threading Mini Support Post

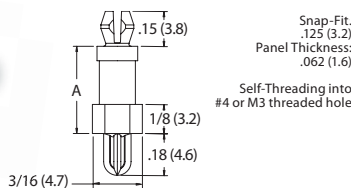
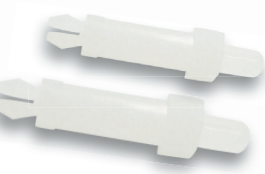

Specifications:

- Material: Nylon 6/6
- Color: Natural
- Flame Class: UL94 V-2

Features:

- Self-threading into #4 or M3 threaded hole

Item No.	A		Bulk Pack Qty.
	In	mm	
MSPMST-2-01	0.125	3.2	1000
MSPMST-3-01	0.188	4.8	1000
MSPMST-4-01	0.250	6.4	1000
MSPMST-5-01	0.313	7.9	1000
MSPMST-6-01	0.375	9.5	1000
MSPMST-7-01	0.438	11.1	1000
MSPMST-8-01	0.500	12.7	1000
MSPMST-9-01	0.563	14.3	1000
MSPMST-10-01	0.625	15.9	1000



RLCBSB
 Metric Reverse Lock Circuit Board Support Push Spacer

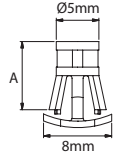
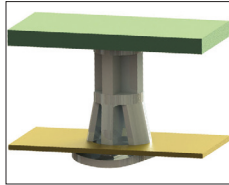

Bottom Hole:
 Snap-lock: 5.5mm
 Panel Thickness:
 .05mm - 1mm

- Mounts from the outside of the chassis
- Material: UL94 V-2 Nylon 6/6
- Color: Natural

Item No.	"A" Standoff Height mm	Bulk Pack Qty.
RLCBSB-5-01	5	1000
RLCBSB-6-01	6	1000
RLCBSB-8-01	8	1000
RLCBSB-10-01	10	1000
RLCBSB-12-01	12	1000
RLCBSB-14-01	14	1000

CBRLSS Series
 Reverse Locking Spacers

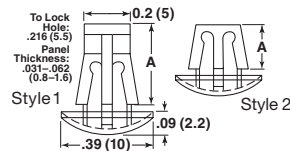

Specifications:

- Material: Nylon 6/6
- Color: Natural
- Flame Class: UL94 V-2

Features:

- Supports heavily loaded circuit boards
- Inserted from the chassis underside
- No fasteners required for mounting due to the one piece design

Item No.	In	mm	Style	Bulk Pack Qty.
CBRLSS005A	0.138	3.5	2	1000
CBRLSS010A	0.197	5.0	2	1000
CBRLSS015A	0.250	6.4	1	1000
CBRLSS020A	0.276	7.0	1	1000
CBRLSS025A	0.312	7.9	1	1000
CBRLSS030A	0.335	8.5	1	1000
CBRLSS035A	0.394	10.0	1	1000
CBRLSS040A	0.472	12.0	1	1000
CBRLSS045A	0.500	12.7	1	1000
CBRLSS050A	0.531	13.5	1	1000

RLCBSRS
 Reverse Locking Circuit Board Support

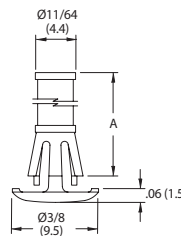
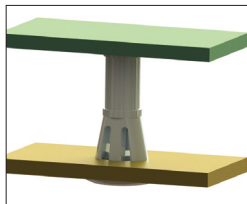

Bottom Hole:
 Snap-lock: .187 (4.75)
 Panel Thickness:
 .059 - .063 (1.5 - 1.6)

- Supports heavily loaded PC boards
- Minimal protrusion under the board
- Inserted from the outside of the chassis
- Material: UL94 V-2 Nylon 6/6
- Color: Natural

Item No.	"A" Standoff Height	Bulk Pack Qty.
RLCBSRS-4-01	1/4 (6.4)	1000
RLCBSRS-5-01	5/16 (7.9)	1000
RLCBSRS-6-01	3/8 (9.5)	1000
RLCBSRS-7-01	7/16 (11.1)	1000
RLCBSRS-8-01	1/2 (12.7)	1000
RLCBSRS-9-01	9/16 (14.3)	1000
RLCBSRS-10-01	5/8 (15.9)	1000

PS/CBPS Series
 Push Spacer

Specifications:

- Material: Nylon 6/6
- Color: Natural
- Flame Class: UL94 V-2

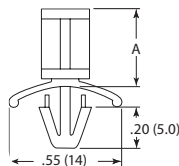

To Lock in Hole:
 .187 (4.8)
 Panel Thickness:
 .031 - .078 (0.8 - 2.0)

Item No.	UL94 V-2	UL94 V-0	In	mm	A	Bulk Pack Qty.
CBPS005A	-	-	0.138	3.5	1000	
PS-3-01	-	PS-3-19	0.188	4.8	1000	
CBPS015A	-	-	0.236	6.0	1000	
PS-4-01	-	PS-4-19	0.250	6.4	1000	
PS-6-01	-	PS-6-19	0.375	9.5	1000	
PS-7-01	-	PS-7-19	0.500	12.7	1000	
PS-8-01	-	PS-8-19	0.563	14.3	1000	
PS-10-01	-	PS-10-19	0.625	15.9	1000	
PS-12-01	-	PS-12-19	0.750	19.1	1000	
PS-14-01	-	PS-14-19	0.875	22.2	1000	
CBPS060A	-	-	0.945	24.0	1000	
CBPS065A	-	-	1.000	25.4	1000	
CBPS070A	-	-	1.125	28.6	500	
CBPS075A	-	-	1.250	31.8	500	
CBPS080A	-	-	1.375	34.9	500	

PSC
 Push Spacer with Cushion

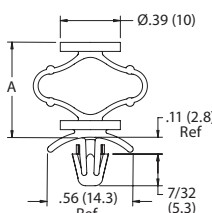
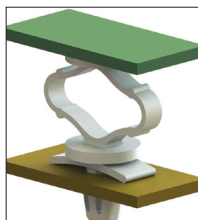

Bottom Hole:
 Snap-lock: .187 (4.75)
 Panel Thickness:
 .031 - .078 (0.79 - 1.98)

- Flexible "spring" spacer absorbs vibration and shock
- Mounts to chassis and supports the PC board
- Material: UL94 HB Impact Modified Nylon 6/6, UV Stabilized
- Color: Natural

Item No.	"A" Spacer Length Uncompressed	Bulk Pack Qty.
PSC-1	3/8 (9.5)	1000
PSC-2	1/2 (12.7)	1000
PSC-3	5/8 (15.9)	1000
PSC-4	3/4 (19.1)	1000

PUSH SPACER SUPPORT POSTS

Buy One or Buy Bulk & SAVE

CBTFS Threaded Female Locking Supports



- Specifications:**
- Material: Nylon 6/6
 - Color: Natural
 - Flame Class: UL94 V-2

- Features:**
- Threaded female support provides an exceptionally robust hold to the chassis
 - Easily disassembled for change or repair in the field

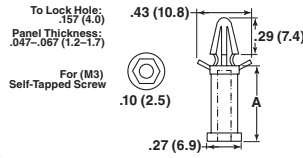

CBTFS Series (Threaded Female Locking Supports) can be used with the following screws:

Threads: M3

SXHM Series - SCSM Series - SPXM Series -
Page: 784 Page: 787 Page: 786



Item No.	In	A mm	Bulk Pack Qty.
CBTFS005A	0.197	5.0	1000
CBTFS010A	0.250	6.4	1000
CBTFS015A	0.276	7.0	1000
CBTFS020A	0.394	10.0	1000
CBTFS025A	0.591	15.0	1000

Item No.	In	A mm	Bulk Pack Qty.
CBTFS030A	0.787	20.0	1000
CBTFS035A	0.984	25.0	1000
CBTFS040A	1.181	30.0	1000
CBTFS045A	1.378	35.0	1000

CBPSW Series Wide Base Push Spacers

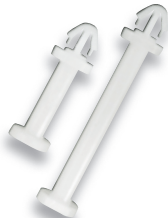

- Specifications:**
- Material: Nylon 6/6
 - Color: Natural
 - Flame Class: UL94 V-2

- Features:**
- The wide base design on both ends provides additional support for heavily loaded PCBs.
 - Eliminates screws, nuts and lock washers from mounting

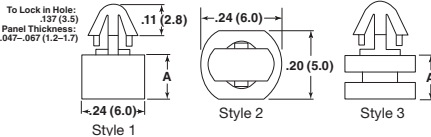

Item No.	In	A mm	Style	Bulk Pack Qty.
CBPSW005A	0.118	3.0	1	2000
CBPSW010A	0.138	3.5	1	2000
CBPSW015A	0.157	4.0	1	2000
CBPSW020A	0.177	4.5	2	2000
CBPSW025A	0.197	5.0	3	2000
CBPSW030A	0.217	5.5	2	2000

Item No.	In	A mm	Style	Bulk Pack Qty.
CBPSW035A	0.236	6.0	2	2000
CBPSW040A	0.256	6.5	2	2000
CBPSW045A	0.276	7.0	2	2000
CBPSW050A	0.531	13.5	2	2000
CBPSW055A	1.024	26.0	2	2000

PSM Mini Push Spacer

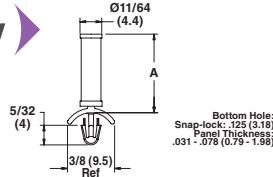
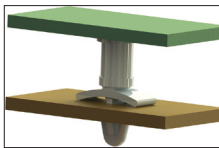

- Supports heavily loaded PC boards
- Often used with Richco LCBS series
- Material: UL94 V-2 Nylon 6/6
- Color: Natural



Item No.	"A" Standoff Height	Bulk Pack Qty.
PSM-2-01	1/8 (3.2)	1000
PSM-3-01	3/16 (4.8)	1000
PSM-4-01	1/4 (6.4)	1000
PSM-5-01	5/16 (7.9)	1000
PSM-6-01	3/8 (9.5)	1000

Item No.	"A" Standoff Height	Bulk Pack Qty.
PSM-7-01	7/16 (11.1)	1000
PSM-8-01	1/2 (12.7)	1000
PSM-9-01	9/16 (14.3)	1000
PSM-10-01	5/8 (15.9)	1000

PSD Metric Push Spacer

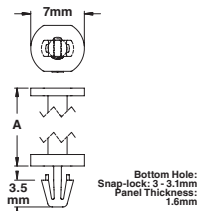
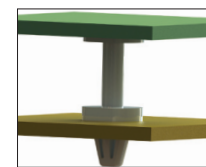

- Sturdy construction supports heavily loaded PCB's
- Allows easy access to underside of board
- Material: Nylon 6/6
- Color: Natural



Item No.	Material: UL94 V-2	Material: UL94 V-0	"A" Standoff Height mm	Bulk Pack Qty.
PSD-4M-01		PSD-4M-19	4	1000
PSD-6M-01		PSD-6M-19	6	1000
PSD-7M-01		PSD-7M-19	7	1000
PSD-8M-01		PSD-8M-19	8	1000
PSD-10M-01		PSD-10M-19	10	1000
PSD-12M-01		PSD-12M-19	12	1000
PSD-14M-01		PSD-14M-19	14	1000
PSD-18M-01		PSD-18M-19	18	1000

CBPS Push In Spacers

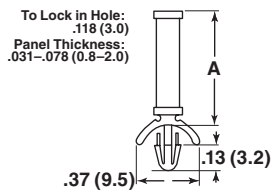

- Specifications:**
- Material: Nylon 6/6
 - Color: Natural
 - Flame Class: UL94 V-2

- Features:**
- The tension wing design offers extra support and a secure fit
 - No fasteners required for mounting due to the one-piece design

Item No.	In	A mm	Bulk Pack Qty.
CBPS105A	0.125	3.2	1000
CBPS110A	0.187	4.8	1000
CBPS115A	0.250	6.4	1000
CBPS120A	0.312	7.9	1000
CBPS125A	0.375	9.5	1000

Item No.	In	A mm	Bulk Pack Qty.
CBPS130A	0.437	11.1	1000
CBPS135A	0.500	12.7	1000
CBPS140A	0.562	14.3	1000
CBPS145A	0.625	15.9	1000
CBPS150A	0.748	19.0	1000

PST Series Teardrop Push Spacer

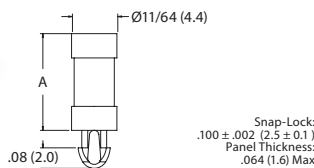

- Specifications:**
- Material: Nylon 6/6
 - Color: Natural
 - Flame Class: UL94 V-2



Item No.	In	A mm	Bulk Pack Qty.
PST-1-01	0.063	1.6	1000
PST-2-01	0.125	3.2	1000
PST-3-01	0.188	4.8	1000
PST-4-01	0.250	6.4	1000
PST-5-01	0.313	7.9	1000

Item No.	In	A mm	Bulk Pack Qty.
PST-6-01	0.375	9.5	1000
PST-7-01	0.438	11.1	1000
PST-8-01	0.500	12.7	1000
PST-9-01	0.563	14.3	1000
PST-10-01	0.625	15.9	1000

PUSH SPACER & THREADED MALE CIRCUIT BOARD SUPPORTS



PST Series Teardrop Push Spacer

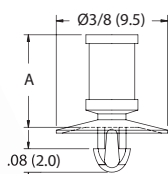

Snap-Lock:
.100 ± .002 (2.5 ± 0.1)
Panel Thickness:
.062 (1.57) Max

Specifications:

- Material: Nylon 6/6
- Color: Natural
- Flame Class: UL94 V-2

Item No.	A		Bulk Pack Qty.
	In	mm	
CPST-2-01	0.125	3.2	1000
CPST-3-01	0.188	4.8	1000
CPST-4-01	0.250	6.4	1000
CPST-5-01	0.313	7.9	1000
CPST-6-01	0.375	9.5	1000
CPST-7-01	0.438	11.1	1000
CPST-8-01	0.500	12.7	1000
CPST-9-01	0.563	14.3	1000
CPST-10-01	0.625	15.9	1000

LCBS/SCBSM/MSCBS/SCBS Series Threaded Male Locking Support

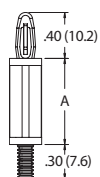
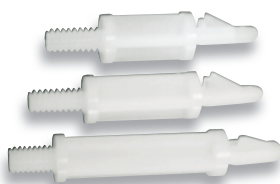

Type 1

Snap-Lock:
.156 ± .003 (4.0 ± 0.1)
Panel Thickness:
.062 (1.6)

Bottom Hole:
#6-32 Thread

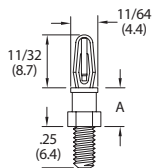

Type 2

Snap-Lock:
.125 (3.2)
Panel Thickness:
.062 (1.6)

CBTMS Series (Threaded Supports) can be used with the following nuts:

Threads: 6-32, 8-32

Threads: M4

HN Series -
Page: 813

NLH Series -
Page: 814

NHS Series -
Page: 813

NHSM Series -
Page: 813



Specifications:

- Material: Nylon 6/6
- Color: Natural

#6-32



Type 1 Item No.	Type 2 Item No.	A		Bulk Pack Qty.	
UL94 V-2	UL94 V-0	Inch	mm		
-	-	SCBSM-632-2-01	0.125	3.2	1000
-	-	SCBSM-632-3-01	0.188	4.8	1000
LCBS-TM-4-01	LCBS-TM-4-19	SCBSM-632-4-02	0.250	6.4	1000
-	-	SCBSM-632-5-01	0.313	7.9	1000
LCBS-TM-6-01	LCBS-TM-6-19	SCBSM-632-6-01	0.375	9.5	1000
-	-	SCBSM-632-7-01	0.438	11.1	1000
LCBS-TM-8-01	LCBS-TM-8-19	SCBSM-632-8-01	0.500	12.7	1000
-	-	SCBSM-632-9-01	0.563	14.3	1000
LCBS-TM-10-01	LCBS-TM-10-19	SCBSM-632-10-01	0.625	15.9	1000
LCBS-TM-12-01	LCBS-TM-12-19	-	0.750	19.1	1000
LCBS-TM-14-01	LCBS-TM-14-19	-	0.875	22.2	1000
LCBS-TM-16-01	LCBS-TM-16-19	-	1.000	25.4	1000

M4

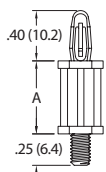

Snap-Lock:
.156 (4.0)
Panel Thickness:
.062 (1.6)

Item No.	A		Bulk Pack Qty.
	In	mm	
UL94 V-2			
MSCBS-4-01	0.250	6.4	1000
MSCBS-6-01	0.375	9.5	1000
MSCBS-8-01	0.500	12.7	1000
MSCBS-10-01	0.625	15.9	1000
MSCBS-12-01	0.750	19.1	1000
MSCBS-14-01	0.875	22.2	1000
CBTMS030A	0.937	23.8	1000
MSCBS-16-01	1.000	25.4	1000
MSCBS-18-01	1.125	28.6	1000
MSCBS-22.5-01	1.406	35.7	1000

#8-32

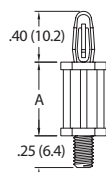

Snap-Lock:
.156 (4.0)
Panel Thickness:
.062 (1.6)

Item No.	A		Bulk Pack Qty.
	In	mm	
UL94 V-2			
SCBS-4-01	0.250	6.4	1000
SCBS-6-01	0.375	9.5	1000
SCBS-8-01	0.500	12.7	1000
SCBS-10-01	0.625	15.9	1000
SCBS-12-01	0.750	19.1	1000
SCBS-14-01	0.875	22.2	1000
SCBS-16-01	1.000	25.4	1000
SCBS-18-01	1.125	28.6	1000
SCBS-22.5-01	1.406	35.7	1000

SCBST Studded Circuit Board Support, Teardrop

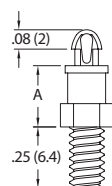
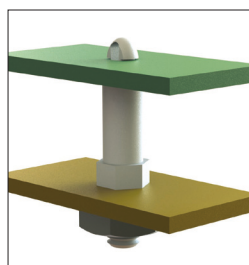

Top Hole:
Snap-lock: .100 (2.54)
Panel Thickness: .064 (1.63)

Bottom Hole:
#6-32 Male Thread

- Secure using nylon hex nut item number HN-6-32-01 (see page 813)
- PC board locks securely in place with minimal protrusion
- Material: UL94 V-2 Nylon 6/6
- Color: Natural

Item No.	"A" Standoff Height	Bulk Pack Qty.
SCBST-3-01	3/16 (4.8)	1000
SCBST-4-01	1/4 (6.4)	1000
SCBST-5-01	5/16 (7.9)	1000
SCBST-6-01	3/8 (9.5)	1000
SCBST-7-01	7/16 (11.1)	1000
SCBST-8-01	1/2 (12.7)	1000
SCBST-9-01	9/16 (14.3)	1000
SCBST-10-01	5/8 (15.9)	1000

THREADED MALE CIRCUIT BOARD SUPPORTS

Buy One or Buy Bulk & SAVE

HMSP-TM Hex Mini Support Post

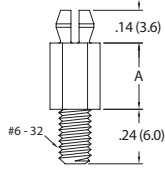
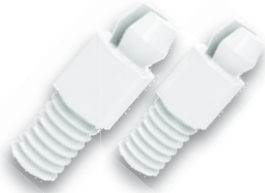

Snap-Fit: .152 (3.9)
Panel Thickness: .062 (1.6)

Specifications:

- Material: Nylon 6/6
- Color: Natural
- Flame Class: UL94 V-2

HMSP Series (Hex Mini Support Posts) can be used with the following nuts:

Threads: 6-32

HN Series - Page: 813 NHL Series - Page: 814 NHS Series - Page: 813



Item No.	"A"		Bulk Pack Qty.
	In	mm	
HMSP-TM-2-01	0.125	3.2	1000
HMSP-TM-3-01	0.188	4.8	1000
HMSP-TM-4-01	0.250	6.4	1000
HMSP-TM-6-01	0.375	9.5	1000
HMSP-TM-8-01	0.500	12.7	1000
HMSP-TM-10-01	0.625	15.9	1000
HMSP-TM-12-01	0.750	19.1	1000
HMSP-TM-14-01	0.875	22.2	1000

CBS-TM Circuit Board Support, Threaded Male

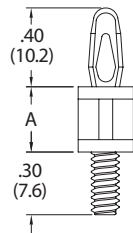
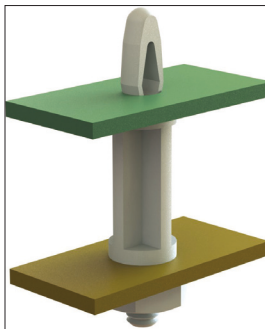

Top Hole: Snap-fit: .156 (4)
Panel Thickness: .062 (1.57)

Bottom Hole: #6-32 Male Thread

- Secure using nylon hex nut item number HN-6-32-01 (see page 813)
- Material: Nylon 6/6
- Color: Natural

Item No.	UL94 V-2	UL94 V-0	"A" Standoff Height	Bulk Pack Qty.
CBS-TM-4-01		CBS-TM-4-19	1/4 (6.4)	1000
CBS-TM-6-01		CBS-TM-6-19	3/8 (9.5)	1000
CBS-TM-8-01		CBS-TM-8-19	1/2 (12.7)	1000
CBS-TM-10-01		CBS-TM-10-19	5/8 (15.9)	1000
CBS-TM-12-01		CBS-TM-12-19	3/4 (19.1)	1000
CBS-TM-14-01		CBS-TM-14-19	7/8 (22.2)	1000
CBS-TM-16-01		CBS-TM-16-19	1 (25.4)	1000
CBS-TM-18-01		CBS-TM-18-19	1 1/8 (28.6)	1000
CBS-TM-20-01		CBS-TM-20-19	1 1/4 (31.8)	1000
CBS-TM-22-01		CBS-TM-22-19	1 3/8 (34.9)	1000
CBS-TM-24-01		CBS-TM-24-19	1 1/2 (38.1)	1000

SRSCBS Snap Rivet Studded Circuit Board Support

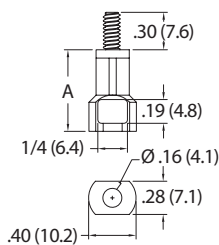
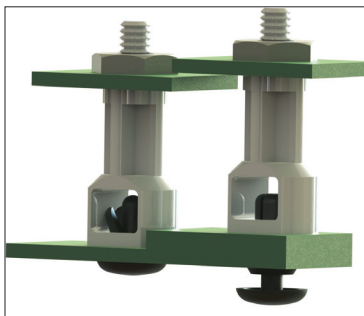

Top Hole: #6-32 Male Thread

Bottom Hole: Snap Rivet: .161 - .165 (4.1 - 4.2)
Panel Thickness: See Rivet Table

Rivet Table	
Use Richco Rivet Item No.	For Chassis Thickness
SR-4050	.026-.062 (0.7-1.6)
SR-4060	.062-.105 (1.5-2.7)
SR-4070	.105-.145 (2.7-3.7)
SR-4080	.145-.184 (3.7-4.7)
SR-4090	.184-.223 (4.7-5.7)
SR-4100	.223-.263 (5.7-6.7)
SR-4120	.282-.341 (7.2-8.7)

- Designed to mount easily on chassis with plastic SR rivet sold separately (see Rivet Table)
- Mounts to PC board with nylon hex nut, item number HN-6-32-01 (see page 813)
- Allows mounting to a range of panel thicknesses; up to .341" thick
- Button head on rivet for minimal protrusion on chassis underside
- Material: UL94 V-2 Nylon 6/6
- Color: Natural

Item No.	"A" Standoff Height	Bulk Pack Qty.
SRSCBS-6-01	3/8 (9.5)	1000
SRSCBS-7-01	7/16 (11.1)	1000
SRSCBS-8-01	1/2 (12.7)	1000
SRSCBS-10-01	5/8 (15.9)	1000
SRSCBS-12-01	3/4 (19.1)	1000
SRSCBS-14-01	7/8 (22.2)	1000
SRSCBS-16-01	1 (25.4)	1000