

# Slide Switch Selection Guide

## PRODUCT LINE FEATURES

- One of the broadest lines in the industry.
- One of six pole configurations.
- Current ratings from 0.4V @ 20VDC to 6A @ 125VAC.
- Miniature and sub-miniature case sizes.
- Gold or silver plating available in most sizes.
- Wave solderable, washable, and surface mount versions.
- Rocker (butt), shoe and bifurcated contact mechanisms.
- Vertical and RA actuator styles.

| CIRCUITRY | SERIES | TERMINATION      | CONTACT RATING/PLATING | ACTUATION            | LIFE EXPECTANCY |
|-----------|--------|------------------|------------------------|----------------------|-----------------|
| SPST      | SSM    | P.C./RIGHT ANGLE | 300mA/SILVER OR GOLD   | STANDARD             | 5K CYCLES       |
|           | TSS    | P.C.             | .4VA/GOLD              | STANDARD/FLUSH       | 80K CYCLES      |
| SPDT      | ASE/F  | P.C./RIGHT ANGLE | 300mA/silver:.4VA/GOLD | STANDARD/FLUSH/RA    | 10K CYCS        |
|           | MAS    | WIRELUG          | 6A @ 125VAC            | STANDARD             | 30K CYCLES      |
|           | MAS    | WIRELUG          | 3A @ 250VAC            | STANDARD             | 30K CYCLES      |
|           | MHS    | P.C.             | .4VA/GOLD:300mA/SILVER | STANDARD/BATON       | 15K CYCLES      |
|           | MKS    | P.C./RIGHT ANGLE | 100MA @ 30VDC          | STANDARD             | 10K CYCLES      |
|           | MLL    | SURFACE MOUNT    | 0.3A @ 4 VDC           | RIGHT ANGLE          | 10K CYCLES      |
|           | MMS    | P.C.             | 100MA/SILVER           | STANDARD/RIGHT ANGLE | 10K CYCLES      |
|           | MSS    | P.C.             | .4VA/GOLD:300MA/SILVER | STANDARD/RIGHT ANGLE | 15K CYCLES      |
|           | MSSA01 | P.C./WIRE WRAP   | .4VA/GOLD              | STANDARD/RIGHT ANGLE | 30K CYCLES      |
|           | MSSA04 | P.C.             | 4A/SILVER              | STANDARD/RIGHT ANGLE | 30K CYCLES      |
|           | SDS    | P.C./RIGHT ANGLE | 300mA @ 125VAC         | STANDARD             | 10K CYCLES      |
|           | SE, AS | P.C./RIGHT ANGLE | .4VA/GOLD              | STANDARD             | 6K CYCLES       |
|           | SL     | P.C.             | 250mA/SILVER           | STANDARD             | 6K CYCLES       |
|           | SLS    | P.C./RIGHT ANGLE | 250mA/SILVER           | STANDARD             | 6K CYCLES       |
|           | SLS/A  | P.C.             | 500mA/SILVER           | STANDARD             | 10K CYCLES      |
|           | SSA    | P.C.             | 100mA/SILVER:.4VA/GOLD | STANDARD             | 10K CYCLES      |
|           | SSB    | P.C.             | 100MA/SILVER:.4VA/GOLD | STANDARD/RIGHT ANGLE | 10K CYCLES      |
|           | SSJ    | P.C.             | 100mA/SILVER           | STANDARD/RIGHT ANGLE | 10K CYCLES      |
|           | SSM    | P.C.             | 250mA/SILVER           | STANDARD             | 5K CYCLES       |
|           | STS    | P.C./RIGHT ANGLE | 300mA/SILVER           | STANDARD             | 10K CYCLES      |
|           | TSS    | P.C./RIGHT ANGLE | .4VA/GOLD              | STANDARD/FLUSH       | 60-80K CYCLES   |
| SP3T      | MHS    | P.C.             | 300MA/SILVER:.4VA/GOLD | STANDARD/BATON       | 15K CYCLES      |
|           | MSS    | P.C.             | 300mA/SILVER:.4VA/GOLD | STANDARD/RIGHT ANGLE | 15K CYCLES      |
|           | MSSA   | P.C.             | 300MA/SILVER:.4VA/GOLD | STANDARD/RIGHT ANGLE | 15K CYCLES      |
|           | SDS    | P.C./RIGHT ANGLE | 300mA @ 125VAC         | STANDARD             | 10K CYCLES      |
|           | SL     | P.C.             | 250mA/SILVER           | STANDARD             | 6K CYCLES       |
|           | SLS    | P.C./RIGHT ANGLE | 250MA/SILVER           | STANDARD             | 6K CYCLES       |
|           | STS    | P.C./RIGHT ANGLE | 300mA/SILVER           | STANDARD             | 10K CYCLES      |
| SP4T      | MSS    | P.C.             | 300mA/SILVER:.4VA/GOLD | STANDARD             | 15K CYCLES      |
|           | MSSA   | P.C.             | 300mA/SILVER:.4VA/GOLD | STANDARD/RIGHT ANGLE | 15K CYCLES      |
|           | SLS    | P.C./RIGHT ANGLE | 250mA/SILVER           | STANDARD             | 6K CYCLES       |
|           | STS    | P.C./RIGHT ANGLE | 300mA/SILVER           | STANDARD             | 10K CYCLES      |
| SP5T      | SL     | P.C.             | 250mA/SILVER           | STANDARD             | 6K CYCLES       |
|           | SLS    | P.C./RIGHT ANGLE | 250mA/SILVER           | STANDARD             | 6K CYCLES       |
|           | STS    | P.C./RIGHT ANGLE | 300mA/SILVER           | STANDARD             | 10K CYCLES      |
| SP6T      | SL     | P.C.             | 250mA/SILVER           | STANDARD             | 6K CYCLES       |
|           | STS    | P.C./RIGHT ANGLE | 300mA/SILVER           | STANDARD             | 10K CYCLES      |
| SP7T      | SL     | P.C.             | 250mA/SILVER           | STANDARD             | 6K CYCLES       |
| SP8T      | SL     | P.C.             | 250mA/SILVER           | STANDARD             | 6K CYCLES       |
| SP10T     | SL     | P.C.             | 250mA/SILVER           | STANDARD             | 6K CYCLES       |
| DPST      | SSM    | P.C.             | 250mA/SILVER           | STANDARD             | 5K CYCLES       |
|           | TSS    | P.C.             | .4VA/GOLD              | STANDARD/FLUSH       | 80K CYCLES      |
| DPDT      | ASE/F  | P.C.             | .4VA/GOLD:300mA SILVER | STANDARD/FLUSH/RA    | 10K CYCLES      |
|           | CSS    | P.C.             | 300mA/SILVER           | BATON                | 15K CYCLES      |
|           | CST    | P.C.             | 300mA/SILVER           | BATON                | 15K CYCLES      |
|           | MAS    | WIRELUG          | 6A @ 125VAC            | STANDARD             | 30K CYCLES      |
|           | MAS    | WIRELUG          | 3A @ 250 VAC           | STANDARD             | 30K CYCLES      |
|           | MHS    | P.C.             | 300mA/SILVER:.4VA/GOLD | STANDARD/BATON       | 15K CYCLES      |
|           | MMS    | P.C.             | 100mA/SILVER           | STANDARD/RIGHT ANGLE | 10K CYCLES      |
|           | MSS    | P.C.             | 300mA/SILVER:.4VA/GOLD | STANDARD/RIGHT ANGLE | 15K CYCLES      |
|           | MSSA01 | P.C.             | .4VA/GOLD              | STANDARD/RIGHT ANGLE | 30K CYCLES      |

Need more technical information?

Consult your local Augat sales office

AUGAT Inc.  
452 John L. Dietsch Blvd.  
Attleboro Falls, MA 02762 USA

# Slide Switch Selection Guide *(continued)*

| CIRCUITRY | SERIES   | TERMINATION      | CONTACT RATING/PLATING  | ACTUATION              | LIFE EXPECTANCY |            |
|-----------|----------|------------------|-------------------------|------------------------|-----------------|------------|
| DPDT      | MSSA04   | P.C.             | .4VA/SILVER             | STANDARD/RIGHT ANGLE   | 30K CYCLES      |            |
|           | MSSA44   | P.C.             | .4VA/GOLD:250mA/SILVER  | STANDARD               | 50K CYCLES      |            |
|           | SDS      | P.C./RIGHT ANGLE | 300mA @ 125 VAC         | STANDARD               | 10K CYCLES      |            |
|           | SE, AS   | P.C./RIGHT ANGLE | .4VA/GOLD               | STANDARD               | 10K CYCLES      |            |
|           | SLS      | P.C.             | 250mA/SILVER            | STANDARD               | 6K CYCLES       |            |
|           | SLS/A    | P.C.             | 500mA/SILVER            | STANDARD               | 10K CYCLES      |            |
|           | SSA      | P.C.             | 100mA/SILVER:.4VA/GOLD  | STANDARD               | 10K CYCLES      |            |
|           | SSA/SSJ  | P.C.             | 100mA/SILVER:.4VA/GOLD  | STANDARD               | 10K CYCLES      |            |
|           | SSM      | P.C.             | 250 mA/SILVER           | STANDARD               | 5K CYCLES       |            |
|           | STS      | P.C./RIGHT ANGLE | 300 mA/SILVER           | STANDARD               | 10K CYCLE       |            |
|           | TSS      | P.C./RIGHT ANGLE | .4VA/GOLD               | STANDARD/FLUSH         | 60-80K CYCLES   |            |
|           | DP3T     | CST              | P.C.                    | 300mA/SILVER           | BATON           | 10K CYCLES |
|           |          | MHS              | P.C.                    | 300mA/SILVER:.4VA/GOLD | STANDARD/BATON  | 15KCYCLES  |
|           |          | MMS              | P.C.                    | 100mA/SILVER           | RIGHT ANGLE     | 10K CYCLES |
| MSSA      |          | P.C.             | 300mA/SILVER:.4VA/GOLD  | STANDARD/RIGHT ANGLE   | 15K CYCLES      |            |
| SDS       |          | P.C./RIGHT ANGLE | 300mA @ 125 VAC         | STANDARD               | 10K CYCLES      |            |
| SLS       |          | P.C.             | 250mA/SILVER            | STANDARD               | 6K CYCLES       |            |
| STS       |          | P.C./RIGHT ANGLE | 300mA/SILVER            | STANDARD               | 10K CYCLES      |            |
| DP4T      |          | MSS              | P.C.                    | 300mA/SILVER:.4VA/GOLD | STANDARD        | 15K CYCLES |
|           | MSSA     | P.C.             | 300mA/SILVER:.4VA/GOLD  | STANDARD/RIGHT ANGLE   | 15K CYCLES      |            |
|           | SLS      | P.C.             | 250mA/SILVER            | STANDARD               | 6K CYCLES       |            |
|           | STS      | P.C./RIGHT ANGLE | 300mA/SILVER            | STANDARD               | 10K CYCLES      |            |
| DP5T      | SLS      | P.C.             | 250mA/SILVER            | STANDARD               | 6K CYCLES       |            |
| DP6T      | STS      | P.C./RIGHT ANGLE | 300mA/SILVER            | STANDARD               | 10K CYCLES      |            |
| 3P3T      | SLS      | P.C.             | 250mA/SILVER            | STANDARD               | 6K CYCLES       |            |
|           | STS      | P.C./RIGHT ANGLE | 300mA/SILVER            | STANDARD               | 10K CYCLES      |            |
| 3P4T      | MSS      | P.C.             | 300mA/SILVER: .4VA/GOLD | STANDARD               | 15K CYCLES      |            |
|           | SSB      | P.C.             | 100mA/SILVER:.4VA/GOLD  | STANDARD               | 10K CYCLES      |            |
| 4PDT      | MSSA     | P.C.             | 300mA/SILVER:.4VA/GOLD  | STANDARD/RIGHT ANGLE   | 15K CYCLES      |            |
|           | ASE/F    | P.C.             | 300mA/SILVER:.4VA/GOLD  | STANDARD/FLUSH/RA      | 10K CYCLES      |            |
|           | CST      | P.C.             | 300mA/SILVER            | BATON                  | 10K CYCLES      |            |
|           | MMS      | P.C.             | 100mA/SILVER            | STANDARD/RIGHT ANGLE   | 10K CYCLES      |            |
|           | MSS      | P.C.             | 300mA/SILVER:.4VA/GOLD  | STANDARD               | 15K CYCLES      |            |
|           | SSB      | P.C.             | 100mA/SILVER:.4VA/GOLD  | STANDARD               | 10K CYCLES      |            |
|           | TSS      | P.C./RIGHT ANGLE | .4VA/GOLD               | STANDARD               | 80K CYCLES      |            |
|           | ASE/F    | P.C.             | 300mA/SILVER            | STANDARD/FLUSH/RA      | 10K CYCLES      |            |
| 4P3T      | CST      | P.C.             | 300mA/SILVER            | BATON                  | 10K CYCLES      |            |
|           | MHS      | P.C.             | 300mA/SILVER:.4VA/GOLD  | STANDARD               | 15K CYCLES      |            |
|           | MMS      | P.C.             | 100mA/SILVER            | STANDARD/RIGHT ANGLE   | 10K CYCLES      |            |
|           | MSS/MSSA | P.C.             | 300mA/SILVER:.4VA/GOLD  | STANDARD/RIGHT ANGLE   | 15L CYCLES      |            |
|           | MSSA     | P.C.             | 300mA/SILVER:.4VA/GOLD  | STANDARD/RIGHT ANGLE   | 15K CYCLES      |            |
| 6PDT      | ASE/F    | P.C.             | 300mA/SILVER:.4VA/GOLD  | STANDARD/FLUSH/RA      | 10K CYCLES      |            |
|           | CST      | P.C.             | 300mA/SILVER:.4VA/GOLD  | BATON                  | 10K CYCLES      |            |
|           | MSS      | P.C.             | 300mA/SILVER:.4VA/GOLD  | STANDARD               | 15K CYCLES      |            |
| 6P3T      | MSS      | P.C.             | 300mA/SILVER:.4VA/GOLD  | STANDARD/RIGHT ANGLE   | 15K CYCLES      |            |



# ASE/F Series *Auto-insertable Slide Switch/ Telecom Grade Thru-hole and Surface Mount*

## ASE/F SERIES DIMENSIONS

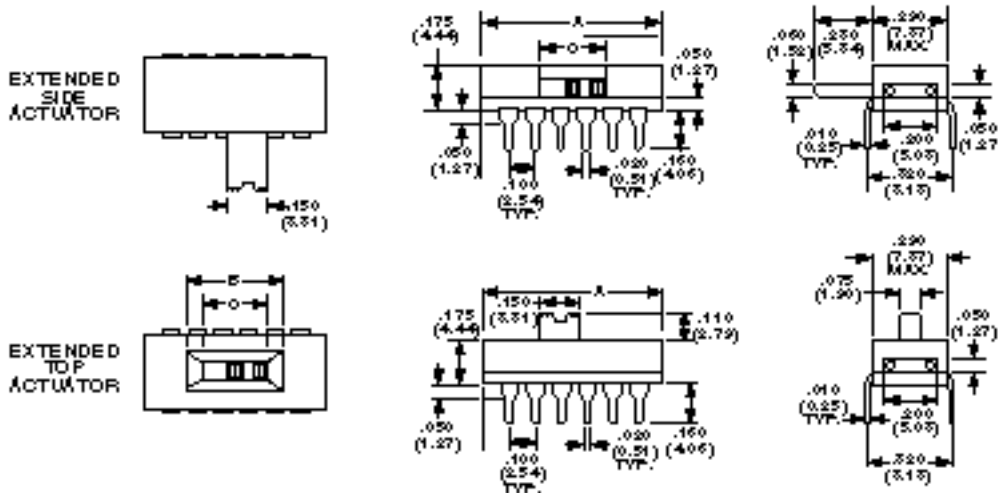
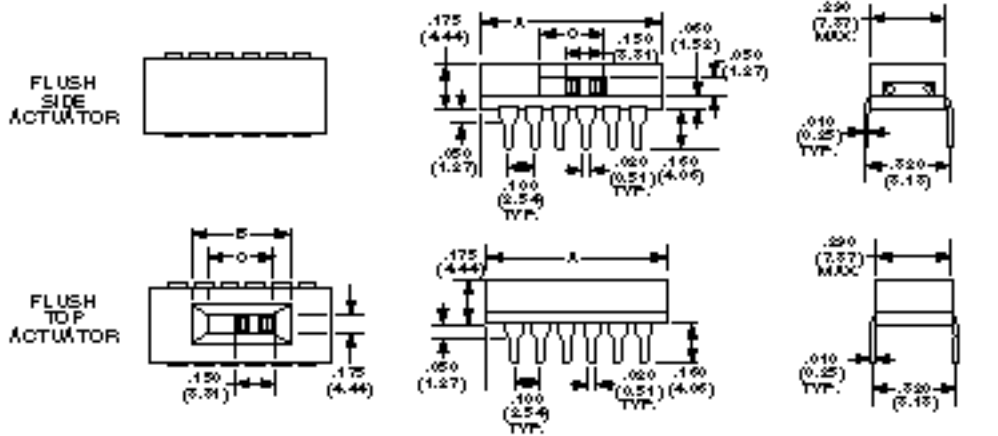

## CIRCUIT DIAGRAMS

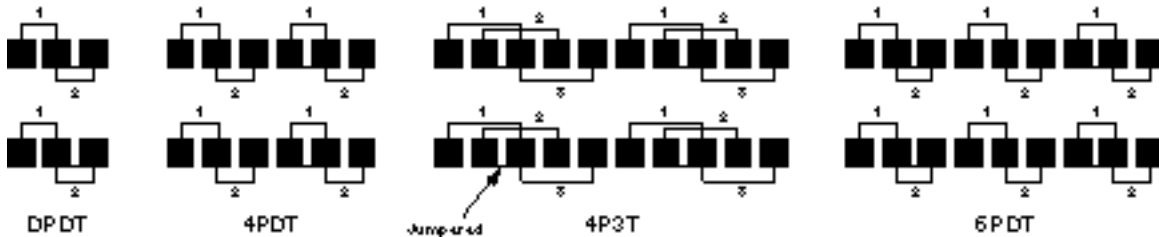

## DIMENSION CHART

| Configuration | PATENT PENDING               |                               |                              |
|---------------|------------------------------|-------------------------------|------------------------------|
|               | Body Length<br>Dimension "A" | Bevel Length<br>Dimension "B" | Slot Length<br>Dimension "C" |
| DPDT          | .400/10.2mm                  | .370/9.4mm                    | .260/6.6mm                   |
| 4PDT          | .700/17.8mm                  | .370/9.4mm                    | .260/6.6mm                   |
| 4P3T          | 1.10/27.9mm                  | .470/11.9mm                   | .360/9.1mm                   |
| 6PDT          | 1.00/25.4mm                  | .370/9.4mm                    | .260/6.6mm                   |

NOTE: P for SPDT requirements order DPDT version and use either set of contacts for SPDT switching.

# Auto-insertable Slide Switch/ Telecom Grade ASE/F Series

“L” PAD

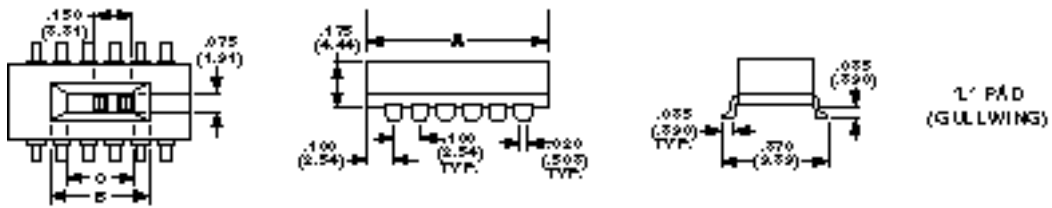

L PAD  
(GULLWING)

REVERSE “S” PAD

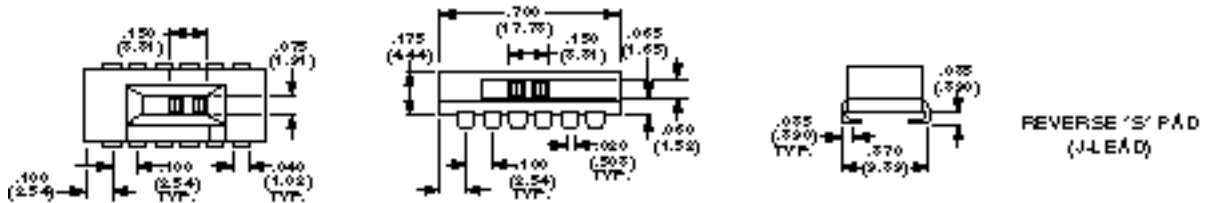

REVERSE 'S' PAD  
(J-LEAD)

## ACTUATOR DETAILS

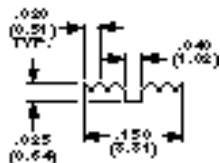

## PAD LAYOUT

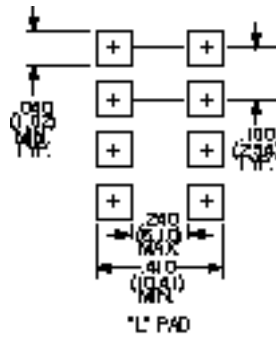

"L" PAD

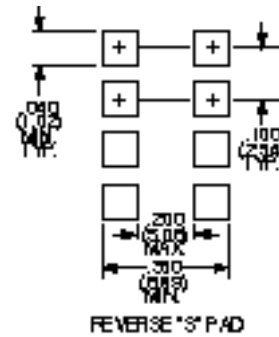

REVERSE 'S' PAD

Additional surface mount lead configurations are available. Contact factory for details. All body and actuator dimensions are identical to standard ASE/F.

Need more technical information?

Contact your local ABE office--(800) 453-1692--or [AboveBoardElectronics.com](http://AboveBoardElectronics.com).

Above Board Electronics  
1918 Junction Avenue  
San Jose, CA 95131

# ASE/F/FO Series *Auto-insertable Slide Switch* Thru Hole and Surface Mount

## MATERIAL SPECIFICATIONS:

Contacts.....Gold over nickel over copper alloy  
Silver over nickel flash over copper alloy  
Case Material/Base .....Polyester  
Actuator Material.....Polyester  
Movable Contact.....Beryllium copper  
Terminal/Fixed Contacts .....Copper alloy, terminals tin lead plate (90/10)  
Terminal Seal.....Insert molded  
Process Seal .....Tape seal on ASF upright version

## ENVIRONMENTAL SPECIFICATIONS:

Operating Temperature.....-20°C to +100°C (-4°F to +212°F)  
Storage Temperature.....-40°C to +20°C (-40°F to +212°F)  
Solder Heat Resistance .....Withstands vapor phase, reflow and wave soldering processes

## TYPICAL PERFORMANCE CHARACTERISTICS:

Contact Rating .....Gold: 0.4 VA @ 20 VDC max. shorting type  
Silver: 300 milliamps @ 115 VDC max. shorting type  
Initial Contact Resistance.....40 Milliohms max.  
Contact Timing .....Shorting  
Insulation Resistance .....1,000 Megohms @ 500 VDC min.  
Dielectric Strength .....1,000 Volts RMS @ sea level  
Actuation Force.....950 Grams max.  
Life Expectancy .....10,000 Cycles min.

**NOTE: Refer to page B5 for additional options and dimensions.**

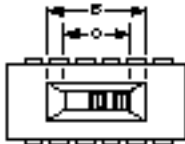

EXTENDED TOP ACTUATOR

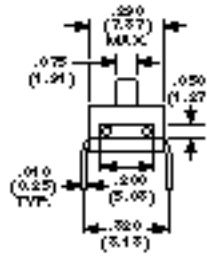
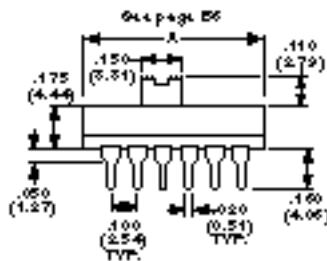

| Model  | Type | Contact | Lever Type |
|--------|------|---------|------------|
| ASE22  | DPDT | Silver  | Upright    |
| ASE22G | DPDT | Gold    | Upright    |
| ASE42  | 4PDT | Silver  | Upright    |
| ASE42G | 4PDT | Gold    | Upright    |
| ASE43  | 4P3T | Silver  | Upright    |
| ASE43G | 4P3T | Gold    | Upright    |
| ASE62  | 6PDT | Silver  | Upright    |
| ASE62G | 6PDT | Gold    | Upright    |

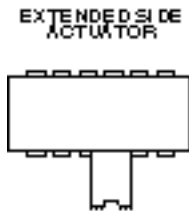

EXTENDED SIDE ACTUATOR

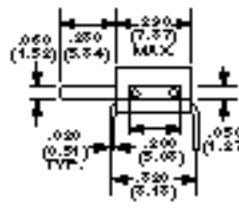
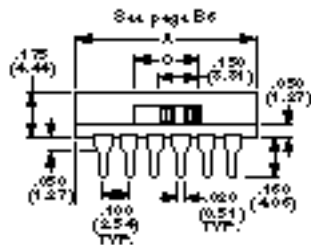

| Model   | Type | Contact | Lever Type  |
|---------|------|---------|-------------|
| ASE22R  | DPDT | Silver  | Right Angle |
| ASE22RG | DPDT | Gold    | Right Angle |
| ASE42R  | 4PDT | Silver  | Right Angle |
| ASE42RG | 4PDT | Gold    | Right Angle |
| ASE43R  | 4P3T | Silver  | Right Angle |
| ASE43RG | 4P3T | Gold    | Right Angle |
| ASE62R  | 6PDT | Silver  | Right Angle |
| ASE62RG | 6PDT | Gold    | Right Angle |

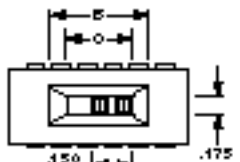

TAPED FLUSH TOP ACTUATOR

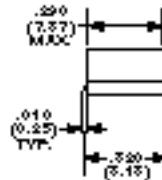
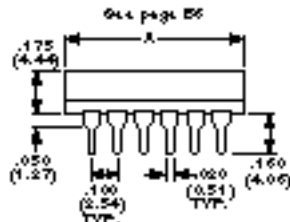

| Model     | Type | Contact | Lever Type |
|-----------|------|---------|------------|
| ASF(*)22  | DPDT | Silver  | Flush      |
| ASF(*)22G | DPDT | Gold    | Flush      |
| ASF(*)42  | 4PDT | Silver  | Flush      |
| ASF(*)42G | 4PDT | Gold    | Flush      |
| ASF(*)43  | 4P3T | Silver  | Flush      |
| ASF(*)43G | 4P3T | Gold    | Flush      |
| ASF(*)62  | 6PDT | Silver  | Flush      |
| ASF(*)62G | 6PDT | Gold    | Flush      |



FLUSH SIDE ACTUATOR

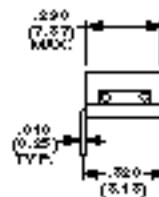
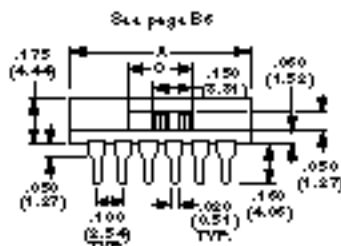

| Model   | Type | Contact | Lever Type         |
|---------|------|---------|--------------------|
| ASF22R  | DPDT | Silver  | Flush, Right Angle |
| ASF22RG | DPDT | Gold    | Flush, Right Angle |
| ASF42R  | 4PDT | Silver  | Flush, Right Angle |
| ASF42RG | 4PDT | Gold    | Flush, Right Angle |
| ASF43R  | 4P3T | Silver  | Flush, Right Angle |
| ASF43RG | 4P3T | Gold    | Flush, Right Angle |
| ASF62R  | 6PDT | Silver  | Flush, Right Angle |
| ASF62RG | 6PDT | Gold    | Flush, Right Angle |